



PRODUCT & PRICE LIST JULY 2024

SHOWER & BATH
LAUNDRY ROOM & UTILITY SINKS
MOP BASINS & WASHER PANS
GRAB BARS & BARRIER FREE PRODUCTS



DIRECT DISTRIBUTORS & MARKETING PROFESSIONALS

WWW.DDMPRO.CA

July 2024

SERVICING THE PLUMBING INDUSTRY SINCE 1996

TABLE OF CONTENTS

Pallet Ordering Guide	3	CABINET-SMITH & DDMPRO	
Shipping Charges (CANADA)	3	Laundry Sink with Cabinet	40
Topaz™ Bathtub Freight Restrictions	3	Bathroom Vanities	41
Conditions of Sale	4		
Warranty	4	ELCOMA GRAB BARS & BARRIER FREE PRODUCTS	
		Straight Grab Bars	42
E.L. MUSTEE & SONS, INC.		Code Approved Grab Bars	43
Quick Reference Numerical Price List	5-6	Angle Grab Bars	44
Complete Shower Stalls	7	Flip-up Bars & Columns	45
Utility Sinks	8-9	Folding Shower Seats	45
Utilatub® & Utilatwin® Laundry Tubs	9-11	Premium Life Line Grab Bars & Seats	45
Utilatub® & Utilatwin® Combo Laundry Tubs	12-13	Life Line Collection	46-47
Fiberglass Bathtub Walls	14-15		
Deluxe Thermoplastic Bathtub Walls	15		
Topaz™ Premium Fiberglass Bathtubs	16		
Fiberglass Shower Bases	17-18		
Easy-Access Shower Floors	19-20		
Fiberglass Shower Walls	21-23		
Thermoplastic Shower Walls	23		
Stylemate® Shower Enclosures	24		
Washer & Water Heater Pans	25		
Mop Service Basins	26-27		
Shower & Bath Ensembles			
Durawall® & Varistone™ Square Showers	29		
Durawall® & Varistone™ Rectangular Showers	30-32		
Ada Easy-Access Shower Ensembles	33-35		
Durawall® Neo-Angle Showers	36		
Topaz™ Premium Fiberglass Bathtub Ensembles	37		
Varistone™ & Durawall® Bathtub Ensembles	38		

PALLET ORDERING GUIDE

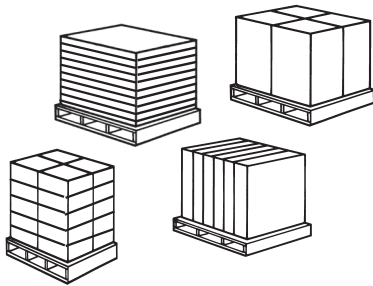

Mustee products can be ordered in pallet lots for easy handling. Review to determine how much product is shipped for a given pallet.

Pallet Packs: Order all like items.
(Example 20 # 18F Laundry Tub is a pallet.)

General Rules for Pallets:

- All single laundry tubs are 20 per pallet.
- All shower floors are 10 per pallet.
- Bathtub and shower wall pallet quantity varies; contact Mustee.
- All bathtubs are 5 per pallet.
- Small mop basins are 24 per pallet.
- Large mop basins are 10 per pallet.

SHIPPING CHARGES (CANADA)

COMMON CARRIER:

FOB Factory, Collect. Contact DDMPRO for prepaid requirements.

UPS (United Parcel Service):

Indicates whether the item can be shipped with a standard carrier.

TOPAZ™ BATHTUB FREIGHT RESTRICTIONS

Due to excessive freight rates, Mustee Topaz™ bathtubs can only be included on prepaid shipments as follows:

- Truckload / ½ Truckload
- Truckload with multi-stop via a contract carrier

Contact your sales representatives or DDMPRO if you are not sure if the Topaz™ bathtub order qualifies for prepaid freight.

CONDITIONS OF SALE

TERMS: NET 30 days, unless sales programs specify differently.

FREIGHT: F.O.B. Direct Distributors Warehouse.

Minimum Order No minimum order level.
No shipments to overdue accounts.

Special Order Items Special order non-stocked items are Not Returnable.

Damages and Shortages Direct Distributors responsibility ceases upon delivery of shipment to the designated carrier. Any shortages must be reported to us within 24 hours after arrival. Any and all visible damage must be noted on the freight bill and signed by the driver. These claims must be made to the freight carrier.

Returns No returns will be accepted without prior authorization. No damaged product will be accepted. Product returned will be subject to a minimum 20% restocking charge. All returned items must be shipped pre-paid.

Defective Goods All goods claimed defective will be subject to inspection before replacement or credit. Defective claims do not include damaged goods.

Product Changes Our continuous commitment of product improvement may result in changes to specifications without notice.

Customer Service

Hours of Operation

Monday to Thursday
Friday

8:00am–4:30pm
8:00am–3:00pm

Shipping/Receiving

Email:
info@ddmpro.ca

Visit our web site at

WWW.DDMPRO.CA

Phone: 905-420-0716

Fax: 905-420-3582

WARRANTY

ONE YEAR LIMITED CONSUMER WARRANTY: We warrant to the original consumer user of the products purchased from DDMPRO for a period of one (1) year from the date of the sale to the consumer that our products will be free of defects in material and workmanship.

Our liability under this Warranty shall be to either repair or replace the product with an identical or reasonably equivalent product. In the alternative, we may refund, in full, the actual purchase price if the repair is not commercially reasonable or possible within a reasonable time and we are unable to supply a replacement product. We shall not be responsible for any labor, damages or installation costs.

This Warranty does not apply to our products which are not installed in accordance with our instructions and local building codes. This Warranty is not applicable if our product has been removed from the original installation or has been subject to accident, abuse or misuse.

After one year from the date of sale, we disclaim all implied warranties of merchantability and fitness for a particular purpose. The foregoing constitutes our entire obligation under this warranty and we make no other express or implied warranties. We further exclude from this warranty all consequential and incidental damages.

A claim under this Warranty may be made through your dealer or, contractor or by writing to our office. Claim must be accompanied by written proof of purchase, photo and may be subject to inspection by a DDMPRO representative – Direct Distributors & Marketing, 817 Brock Rd., unit #9, Pickering, ON L1W 3L9.



	Model No.	List Price	Page
Durastall + Durastall Accessories	30	\$680.00	7
	68	600.00	7
	80	895.00	7
	140	1,100.00	7
	48.700	468.00	7
	68.600	86.00	7
	80.400P	100.00	7
	82.400A	75.00	18
	86.500	270.00	7
	88.700	412.00	7
	10	210.00	8
10K	190.00	8	
10C	220.00	8	
11	204.00	8	
11K	182.00	8	
20	130.00	8	
2218	352.00	9	
25	298.00	8	
25K	270.00	8	
25PD	400.00	8	
25TW	400.00	8	
Laundry/Utility Sinks	12C	310.00	12
	12K	122.00	11
	14CP	282.00	12
	14K	112.00	11
	15F	250.00	10
	15W	250.00	10
	16	162.00	11
	16K	156.00	11
	17F	278.00	9
	17W	278.00	9
	18F	265.00	9
18FK	240.00	9	
18W	265.00	9	

	Model No.	List Price	Page
Laundry/Utility Tubs (Continued)	19F	\$238.00	10
	19FK	210.00	10
	19W	238.00	10
	19CF	358.00	12
	19CFP	300.00	12
	21F	160.00	10
	22C	495.00	12
	24C	510.00	12
	26F	495.00	9
	26W	495.00	9
	27F	432.00	11
	27W	432.00	11
	28F	465.00	10
	28CF	600.00	13
Laundry/Utility Tub Accessories	12.400F	58.00	13
	15.600	112.00	13
	17.250W	82.00	13
	18.200W	85.00	13
	18.300F	82.00	13
	19.204A	70.00	9
	20.600	12.00	13
	25.300	100.00	8
	28.600A	210.00	13
	93.600	170.00	13
	53WHT	508.00	15
	56WHT	618.00	15
	350WHT	1,100.00	14
	500WHT	992.00	15
557WHT	872.00	15	
572TWHT	1,850.00	14	
665WHT	900.00	14	
670WHT	840.00	14	
680WHT	885.00	14	
680WHTBB	1,250.00	14	
680-32WHT	980.00	14	
950	400.00	15	

	Model No.	List Price	Page	
Bathtubs	T6030L	\$542.00	16	
	T6030L-AFD	692.00	16	
	T6030R	542.00	16	
	T6030R-AFD	692.00	16	
	T6032L	650.00	16	
	T6032R	650.00	16	
	Shower Floors	3232M	332.00	17
		3248M	452.00	17
		3254M	588.00	17
		3260M	612.00	17
3434DTM		450.00	18	
3434M		568.00	17	
3442M		442.00	17	
3448M		465.00	17	
3454M		538.00	17	
3460M		598.00	17	
3636CM		418.00	18	
3636DTM		465.00	18	
3636M		395.00	17	
3642M		480.00	17	
3648M		496.00	17	
3660M		642.00	17	
3838CM		465.00	18	
4236M		465.00	17	
4242CM	684.00	18		
4242M	518.00	17		
4248M	810.00	17		
4260M	885.00	17		
4848M	865.00	17		

	Model No.	List Price	Page
Easy Access Shower Floors	3060L	\$540.00	19
	3060R	540.00	19
	360L	722.00	19
	360R	722.00	19
	3739M	490.00	20
	3865	1,100.00	20
Shower Walls	237WHT	498.00	23
	247WHT	665.00	23
	260WHT	940.00	23
	265WHT	940.00	23
	572TWHT	1,850.00	21
	732SWHT	1,125.00	22
	736CWHT	1,050.00	22
	736SWHT	1,230.00	22
	738CWHT	1,150.00	23
	742CWHT	1,450.00	23
	748-32SWHT	1,278.00	22
	748-34SWHT	1,278.00	22
	760T-30WHT	1,670.00	21
	760T-34WHT	1,800.00	21
	760T-36WHT	1,800.00	21
	700.2W	620.00	22
	742.1W	742.00	23
	748.32W	500.00	22
	748.34W	500.00	22
	760T.1	600.00	21
760T.2	600.00	21	
760T.6	380.00	21	
760T.10	650.00	21	
760T.12	560.00	21	
Grab Bars	01-5212KT	52.00	43
	01-5216KT	58.00	43
	01-5218KT	60.00	43
	01-5224KT	72.00	43
	01-5230KT	76.00	43
	01-5232KT	78.00	43
	01-5236KT	84.00	43
	01-5242KT	92.00	43
	07-522416KT	130.00	43
	07-523216KT	145.00	43
	08-522416KT	130.00	43
	08-523216KT	145.00	43
	09-523030KT	154.00	43
09-523636KT	190.00	43	

	Model No.	List Price	Page	
Shower Seats	62-PH2601	\$480.00	45	
	62-PH2801	496.00	45	
	62-PH3201	524.00	45	
	62-PA2601	480.00	45	
	62-PA2801	496.00	45	
	62-PA3201	524.00	45	
	62-PH1451601	382.00	45	
	62-PA1451601	382.00	45	
	62-PH1451801	412.00	45	
	62-PA1451801	412.00	45	
	Shower Doors/Enclosures	32.705	695.00	24
		32.706	900.00	24
		36.403	760.00	24
36.404		748.00	24	
36.750		1,250.00	24	
36.761		1,250.00	24	
36.762		1,400.00	24	
36.763		1,400.00	24	
38.750		1,250.00	24	
38.751		1,350.00	24	
38.752		1,650.00	24	
38.753		1,650.00	24	
42.751		1,500.00	24	
42.752		1,800.00	24	
42.753		1,800.00	24	
48.403		1,650.00	24	
48.406		1,310.00	24	
48.407		1,310.00	24	
48.408		1,310.00	24	
60.403		1,450.00	24	
60.406	1,560.00	24		
60.407	1,560.00	24		
60.408	1,560.00	24		

	Model No.	List Price	Page	
Bath + Shower Accessories	32.401	\$24.00	18	
	32.404	24.00	18	
	32.405	24.00	18	
	42.320	23.00	7	
	42.321	23.00	19	
	42.322	23.00	18	
	42.326	45.00	18	
	42.327	45.00	18	
	42.330	23.00	19	
	360.100	360.00	19	
	360.210	89.00	19	
	300.600W	300.00	15	
	42.317A	45.00	18	
	42.400A	75.00	18	
	52.600W	165.00	15	
	572.300	85.00	21	
	60.300A	123.00	19	
	60.320A	50.00	18	
	Durapan Washer + Water Heater Pans	95	192.00	25
		96	128.00	25
98		238.00	25	
99		249.00	25	
Mop Basins + Accessories		63.401	48.00	27
	63.403	80.00	27	
	63.600A	230.00	27	
	65.308	26.00	27	
	65.309	26.00	27	
	65.311	26.00	27	
	65.403	62.00	27	
	65.404	84.00	27	
	65.600	140.00	27	
	65.700	88.00	27	
	67.2424	262.00	27	
	67.2436	268.00	27	
	63M	400.00	26	
65M	445.00	26		

COMPLETE SHOWER STALLS

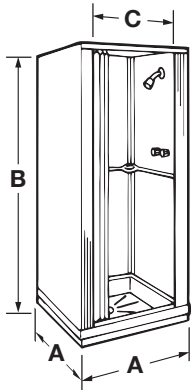

Model No.	Nom. Size	A	B	C	Base	UPC	Lbs.	Cu. Ft.	Ship Via	List Price
-----------	-----------	---	---	---	------	-----	------	---------	----------	------------

80, 140 DURASTALL® – Complete knock-down shower stall includes base, walls, curtain, shower valve, handrail and drain.

80	32"x32"	32 ⁵ / ₈ "	75 ³ / ₈ "	24"	Standard	6 71031 00314 0	55	7.0		\$895.00
140	36"x36"	36 ⁵ / ₈ "	75 ³ / ₈ "	28"	Standard	6 71031 00316 4	61	8.0		1,100.00

30, 68 DURASTALL® – Complete knock-down shower stall includes base, walls, curtain, shower valve, handrail and drain.

30	30"x30"	30 ¹ / ₈ "	73"	24"	Standard	6 71031 00059 0	38	6.3	UPS	680.00
68	32"x32"	32 ⁵ / ₈ "	74 ³ / ₄ "	24"	Standard	6 71031 00200 6	40	6.8	UPS	600.00

ACCESSORIES

Model No.	Description	Fits Models	UPC	Lbs.	Cu. Ft.	Ship Via	List Price
-----------	-------------	-------------	-----	------	---------	----------	------------

GLASS SHOWER DOORS – Obscure, Tempered Safety Glass with Aluminum Frame

88.700	24" opening	80	6 71031 00223 5	25	2.5		412.00
48.700	28" opening	140	6 71031 00170 2	26	2.9		468.00

SHOWER VALVES

68.600	Shower valve	68	6 71031 00201 3	0.7	—	UPS	86.00
80.400P	Shower valve	30, 80, 140	6 71031 00217 4	1.6	—	UPS	100.00

DRAIN SEAL

42.320	Drain seal — for 2" copper, use with drain #42.317A		6 71031 00309 6	—	—	UPS	23.00
--------	---	--	-----------------	---	---	-----	-------

EXTENDED BASE KIT

86.500		80, 140	6 71031 00521 2	23	2.1	UPS	270.00
--------	--	---------	-----------------	----	-----	-----	--------

Fits models 80 and 140 purchased after 6-1-16

FIBERGLASS UTILITY SINKS

Model No.	Colors	Quantity Packs	UPC	Lbs.	Cu. Ft.	Ship Via	List Price
-----------	--------	----------------	-----	------	---------	----------	------------

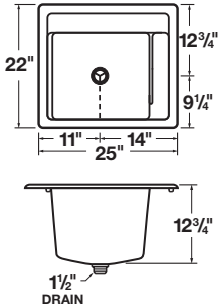

MODEL 25 VECTOR™ MULTI-TASK SINK – Self-rimming, includes drain for 1 1/2" P-Trap. Colorfast finish. Optional 25.300 utility rack.

25	White		6 71031 00417 8	21	5.0		\$298.00
25K	White	4-Pack	—	72	9.4		270.00
25PD	Prairie Drift		6 71031 00427 7	21	5.0		400.00
25TW	Twilight		6 71031 00426 0	21	5.0		400.00

Inside Bowl – 15 1/2" x 22" x 12 3/4"
Cut Out – 21" x 24"

ACCESSORIES



UTILITY RACK – 21" x 14 1/2"

25.300	White		6 71031 00423 9	2.8	0.4	UPS	100.00
--------	-------	--	-----------------	-----	-----	-----	--------

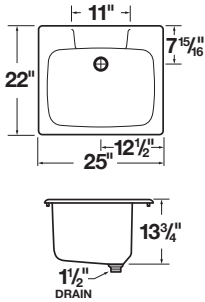

MODEL 10 – Self-rimming, includes drain for 1 1/2" P-Trap. Colorfast finish.

10	White		6 71031 00001 9	16	5.0		210.00
10K	White	4-Pack	—	64	10.0		190.00

*Bone colour available by special order

Inside Bowl – 15 1/4" x 21 3/8" x 13 1/4"
Cut Out – 21" x 24"

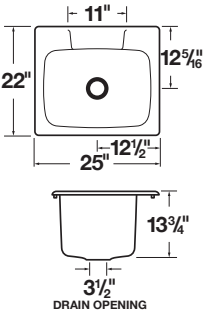

MODEL 10C – Self-rimming, 3 1/2" drain opening. Colorfast finish.

10C	White		6 71031 00300 3	17	5.0		220.00
-----	-------	--	-----------------	----	-----	--	--------

Inside Bowl – 15 3/4" x 21 3/8" x 13 1/4"
Cut Out – 21" x 24"

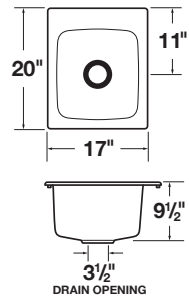

MODEL 11 – Self-rimming, 3 1/2" drain opening. Colorfast finish.

11	White		6 71031 00253 2	11	2.8	UPS	204.00
11K	White	6-Pack	—	50	5.3		182.00

Inside Bowl – 15" x 14" x 9 1/2"
Cut Out – 18 1/2" x 15 1/2"

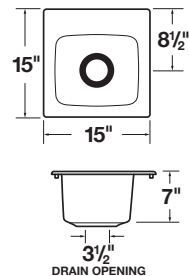

MODEL 20 BAR SINK – Self-rimming, 3 1/2" drain opening. Colorfast finish.

20	White		6 71031 00236 5	8	1.3	UPS	130.00
----	-------	--	-----------------	---	-----	-----	--------

Inside Bowl – 10" x 12" x 7"
Cut Out – 13 1/2" x 13 1/2"

FIBERGLASS UTILITY SINKS (Continued)

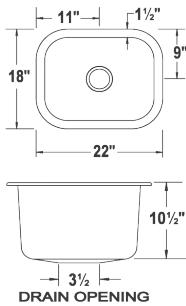

Model No.	Colors	Quantity Packs	UPC	Lbs.	Cu. Ft.	Ship Via	List Price
-----------	--------	----------------	-----	------	---------	----------	------------

MODEL 2218 UNDERMOUNT OR TOP MOUNT SINK – 3 1/2" drain opening.

2218	White		671031 005229	16	3.8	UPS	\$352.00
------	-------	--	---------------	----	-----	-----	----------

Undermount Cut Out – 15" x 19", with round corners (See instructions.)
Drop In Cut Out – 15 1/2" x 19 1/2" (See instructions.)

See template included with sink for exact measurements.

UTILATUB® & UTILATWIN® LAUNDRY TUBS

DURASTONE® LAUNDRY TUBS

Model No.	Style / Mount	Quantity Packs	UPC	Lbs.	Cu. Ft.	Ship Via	List Price
-----------	---------------	----------------	-----	------	---------	----------	------------

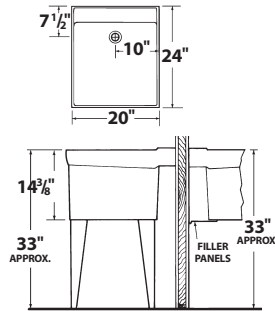

18F/W UTILATUB® – Floor or wall mount. Connects to standard 1 1/2" P-Trap.

18F	Single / Floor		671031 000262	28	4.8		265.00
18W	Single / Wall		671031 000279	25	4.8		265.00
18FK	Single / Floor	4-Pack	—	105	8.7		240.00

ACCESSORIES



UTILATOP™ LAUNDRY TUB TOP COVER – Provides additional counter space, fits 18F, 18W, 19F and 19W.

19.204A	Single		671031 003805	3.2	0.3	UPS	70.00
---------	--------	--	---------------	-----	-----	-----	-------

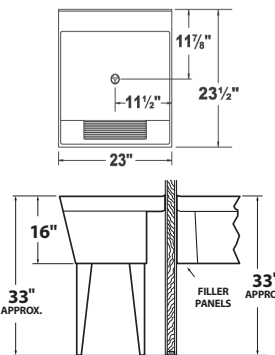

17F/W UTILATUB® – With built-in scrub board and floor or wall mount hardware. Connects to standard 1 1/2" P-Trap.

17F	Single / Floor		671031 000231	31	5.9		278.00
17W	Single / Wall		671031 000248	29	5.9		278.00

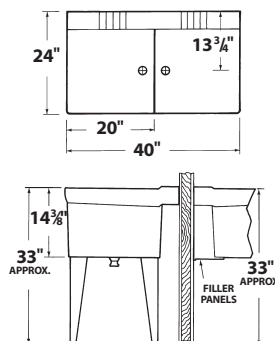

26F/W UTILATWIN® – Floor or wall mount. Connects to standard 1 1/2" P-Trap.

26F	Double / Floor		671031 000545	48	9.6		495.00
26W	Double / Wall		671031 000552	48	9.6		495.00

THERMOPLASTIC LAUNDRY TUBS

Model No.	Style / Mount	Quantity Packs	UPC	Lbs.	Cu. Ft.	Ship Via	List Price
-----------	---------------	----------------	-----	------	---------	----------	------------

19F/W UTILATUB® – Floor or wall mount. Connects to standard 1 1/2" P-Trap.

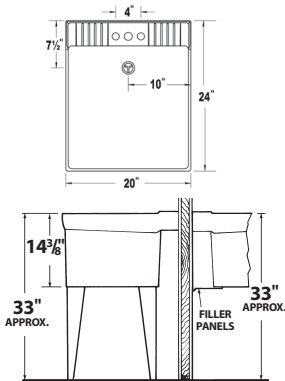

19F	Single / Floor		6 71031 00029 3	19	4.8	UPS	\$238.00
19W	Single / Wall		6 71031 00030 9	17	4.8	UPS	238.00
19FK	Single / Floor	4-Pack	—	70	8.7		210.00

ACCESSORIES



UTILATOP™ LAUNDRY TUB TOP COVER – Provides additional counter space, fits 18F, 18W, 19F and 19W.

19.204A	Single		6 71031 00380 5	3.2	0.3	UPS	70.00
---------	--------	--	-----------------	-----	-----	-----	-------

15F/W UTILATUB® – With a built-in scrub board and floor or wall mount. Connects to standard 1 1/2" P-Trap.

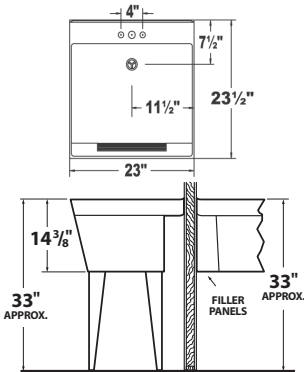

15F	Single / Floor		6 71031 00018 7	21	5.1	UPS	250.00
15W	Single / Wall		6 71031 00019 4	19	5.1	UPS	250.00

21F LILTUB™ UTILATUB® – Multi-purpose floor sink with narrow bowl for installation in almost any space. Connects to standard 1 1/2" P-Trap.

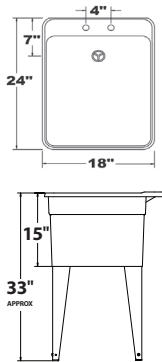

21F	Floor		6 71031 00502 1	42	4.1	UPS	160.00
-----	-------	--	-----------------	----	-----	-----	--------

28F UTILATUB® – Large single bowl multi-purpose floor sink. Inside dimensions: 36 1/2" wide x 17 1/2" deep. Connects to standard 1 1/2" P-Trap.

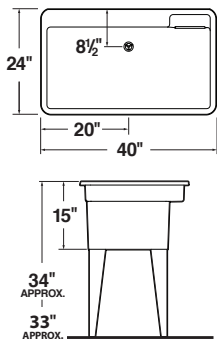

28F	Floor		6 71031 00499 4	23	9.6	UPS	465.00
-----	-------	--	-----------------	----	-----	-----	--------

THERMOPLASTIC LAUNDRY TUBS

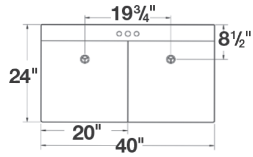

27F/W UTILATWIN®—Floor or wall mount. Connects to standard 1 1/2" P-Trap.

Model No.	Style / Mount	Quantity Packs	UPC	Lbs.	Cu. Ft.	Ship Via	List Price
27F	Double / Floor		6 71031 00057 6	40	9.6	UPS	\$432.00
27W	Double / Wall		6 71031 00058 3	40	9.6	UPS	432.00

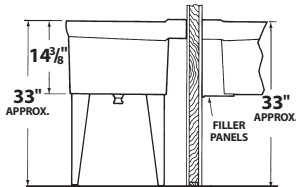

CO-POLYPURE™ LAUNDRY TUBS

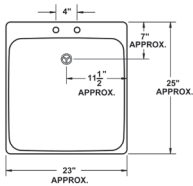

14 UTILATUB® – Floor mount. Connects to standard 1 1/2" P-Trap.

Model No.	Style / Mount	Quantity Packs	UPC	Lbs.	Cu. Ft.	Ship Via	List Price
14K	Single	5-Pack	—	65	10.6	UPS	112.00

See page 12 for single unit combos with faucet

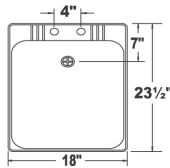
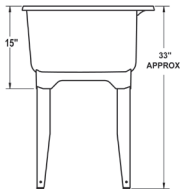

12 UTILATUB® – Floor mount. Extra-narrow 18" width. Connects to standard 1 1/2" P-Trap.

Model No.	Style / Mount	Quantity Packs	UPC	Lbs.	Cu. Ft.	Ship Via	List Price
12K	Single	4-Pack	—	42	7.3	UPS	122.00

See page 12 for single unit combos with faucet

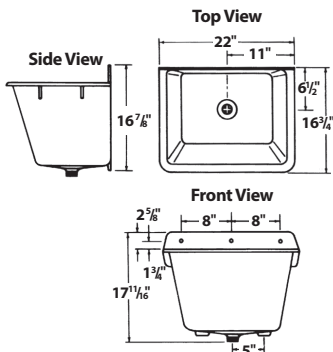
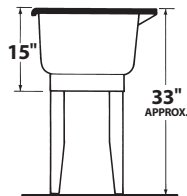

16 SERVICE MOP SINK – Wall mount. Connects to standard 1 1/2" P-Trap.

Model No.	Style / Mount	Quantity Packs	UPC	Lbs.	Cu. Ft.	Ship Via	List Price
16	Single		6 71031 00297 6	12	3.2	UPS	162.00
16K	Single	6-Pack	—	60	6.7		156.00

UTILATUB® AND UTILATWIN® COMBO KITS

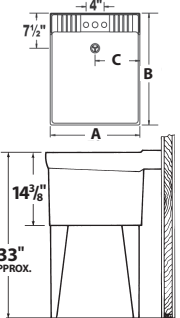
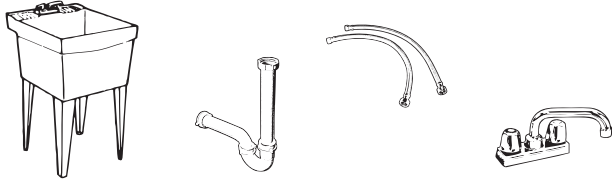
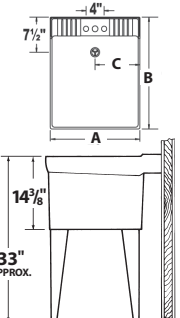
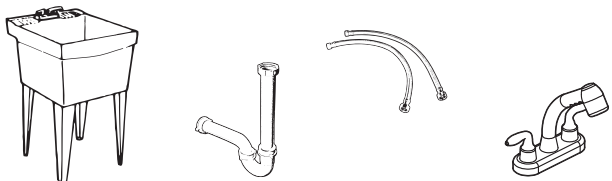
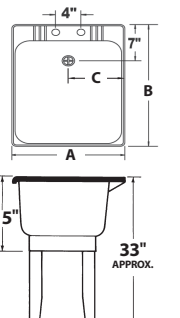
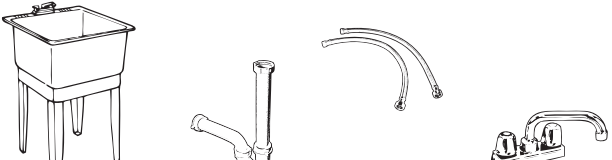
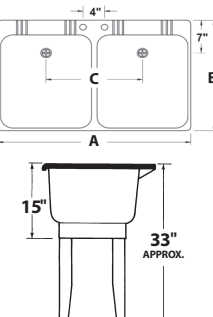
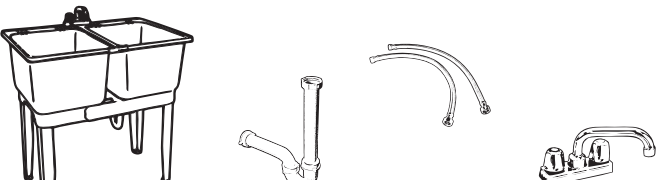
Model No.	Style	(A)	(B)	(C)	Height	UPC	Lbs.	Cu. Ft.	Ship Via	List Price
	19CF UTILATUB® COMBO									
	19CF	Single / Floor	20"	24"	10"	34"	671031 00346 1	26	4.8	UPS
<p>KIT INCLUDES: LAUNDRY TUB, SWIVEL FAUCET, SUPPLY LINES, 1 1/2" P-TRAP, STOPPER AND TEFLON® TAPE</p>										
	19CFP UTILATUB® COMBO WITH TOP COVER 19.204A									
	19CFP	Single / Floor	20"	24"	10"	34"	671031 00424 6	26	4.8	UPS
<p>KIT INCLUDES: LAUNDRY TUB, SWIVEL FAUCET, SUPPLY LINES, 1 1/2" P-TRAP, STOPPER AND TEFLON® TAPE</p>										
	12C/14CP UTILATUB® COMBO									
	12C	Single / Floor	18"	23 1/2"	9"	34"	671031 00388 1	17	4.1	UPS
14CP	Single / Floor	23"	25"	11 1/2"	34"	671031 00347 8	19.5	5.5	UPS	282.00
<p>KIT INCLUDES: LAUNDRY TUB, SWIVEL FAUCET, SUPPLY LINES, 1 1/2" P-TRAP, STOPPER AND TEFLON® TAPE</p>										
	22C/24C UTILATWIN® COMBO									
	22C	Double / Floor	36"	23 1/2"	18"	34"	671031 00389 8	25.5	5.5	UPS
24C	Double / Floor	46"	25"	23"	34"	671031 00044 6	27.5	6.1	UPS	510.00
<p>KIT INCLUDES: LAUNDRY TUB, SWIVEL FAUCET, SUPPLY LINES, 1 1/2" P-TRAP, STOPPERS AND TEFLON® TAPE</p>										

UTILATUB® AND UTILATWIN® COMBO KITS (Continued)

Model No.	Style	(A)	(B)	(C)	Height	UPC	Lbs.	Cu. Ft.	Ship Via	List Price
-----------	-------	-----	-----	-----	--------	-----	------	---------	----------	------------

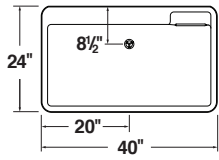

28CF BIGTUB™ UTILATUB® COMBO

28CF	Wide Single / Floor	40"	24"	20"	34"	6 71031 00489 5	40	9.6	UPS	\$600.00
------	---------------------	-----	-----	-----	-----	-----------------	----	-----	-----	----------

KIT INCLUDES: LAUNDRY TUB, SWIVEL FAUCET WITH PULL-OUT SPOUT, SUPPLY LINES, 1 1/2" P-TRAP, STOPPER AND TEFLON™ TAPE

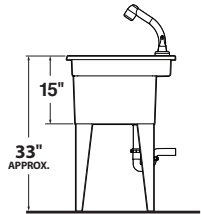
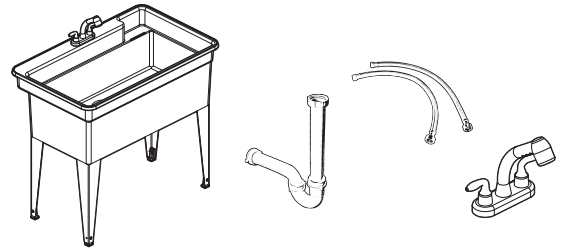

ACCESSORIES

Model No.	Description	Fits	UPC	Lbs.	Cu. Ft.	Ship Via	List Price
-----------	-------------	------	-----	------	---------	----------	------------

FAUCET, FAUCET BLOCKS, TWIN WASTE

93.600	FAUCET – chrome plated 4" center set with brass body		6 71031 00232 7	2	—	UPS	170.00
20.600	FAUCET BLOCK – molded		6 71031 00031 6	0.2	—	UPS	12.00
26.619	TWIN WASTE ASSEMBLY – for 26F/W or older 27F/W		—	1	—	UPS	78.00



MOUNTING HARDWARE

12.400F	FLOOR MOUNTING HARDWARE – for 14, 24, 12 & 22		6 71031 00490 1	5		UPS	58.00
18.300F	FLOOR MOUNTING HARDWARE – for 15F, 17F, 18F & 19F		6 71031 00014 9	5		UPS	82.00
17.250W	WALL MOUNTING HARDWARE – for 17W		6 71031 00021 7	2		UPS	82.00
18.200W	WALL MOUNTING HARDWARE – for 15W, 18W & 19W		6 71031 00013 2	2		UPS	85.00



COMBO INSTALLATION KIT

– Includes faucet, P-Trap, (2) supply lines and Teflon tape.

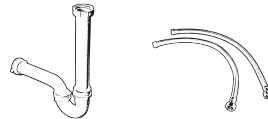
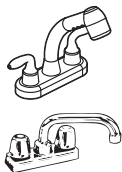
28.600A	PULL-OUT FAUCET – P-Trap, (2) supply lines & Teflon tape		6 71031 00498 7	3	0.2	UPS	210.00
15.600	FAUCET (PLASTIC) – P-Trap, (2) supply lines & Teflon tape		6 71031 00491 8	3	0.2	UPS	112.00

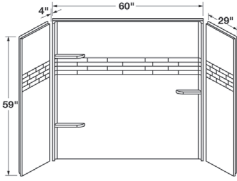
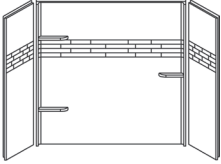
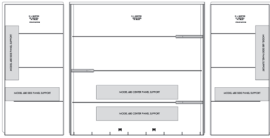
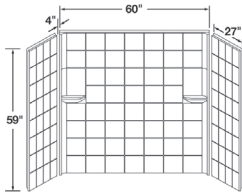
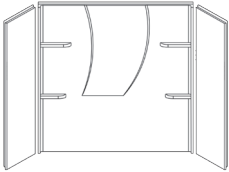
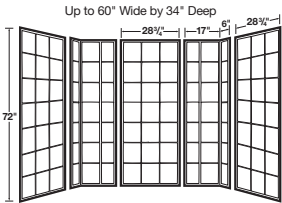

PREMIUM FIBERGLASS BATHTUB WALLS

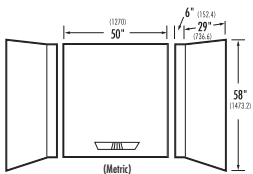
	Model No.	Colors	UPC	Lbs.	Cu. Ft.	Ship Via	List Price
	680-32 TOPAZ™	– Fits Mustee’s Topaz™ bathtub T6032R/L and most other 32"x 60" bathtub. Fiberglass construction; mounts direct to stud; large molded-in shelf; smooth, semi-gloss finish.					
	680-32WHT	White	6 71031 00551 9	80	13.0		\$980.00
	680 TOPAZ™	– Fits Mustee’s Topaz™ bathtub T6030R/L and most other 30"x 60" bathtub. Fiberglass construction; mounts direct to stud.					
	680WHT	White	6 71031 00549 6	86	12.0		885.00
	680WHTBB	– Fits Mustee’s Topaz™ bathtub T6030R/L and most other 30" x 60" bathtub. Model 680WHT with backer boards preinstalled at the factory for ADA applications. There are 6 backer boards placed to mount T-style grab bars. Order in pallet lots of 8.					
	680WHTBB	White	6 71031 00550 2	95.5	12.0		1,250.00
	670 TOPAZ™	– Fits Mustee’s Topaz™ bathtub T6030R/L and most other 30"x 60" bathtub. Molded fiberglass construction with distinctive 7"x 7" tile pattern. Mounts direct to stud. Semi-gloss finish.					
	670WHT	White	6 71031 00504 5	86	12.0		840.00
	665 TOPAZ™	– Fits Mustee’s Topaz™ bathtub T6030R/L and most other 30"x 60" bathtub. Fiberglass construction; requires no caulk and mounts direct to stud; large molded-in shelf; smooth, semi-gloss finish.					
	665WHT	White	6 71031 00587 8	86	12.0		900.00
			NEW	* REQUIRES NO CAULK *			
	572T VARISTONE™	– Fits Mustee’s Topaz™ bathtub and any standard bathtub up to 60" x 34". Tall 72" high. Fiberglass construction; embossed tile pattern; adhesive mounts; smooth, semi-gloss finish.					
	572TWHT	White	6 71031 00420 8	110	9.9		1,850.00
	ACCESSORY VARISTONE™ SHELVES – 7" high 572.300 – See pg. 21 for more details.						
	350 DURAWALL®	– Fits Mustee’s Topaz™ bathtub and any 30" x 60" bathtub. Fiberglass, adhesive mounts, smooth, semi-gloss finish. Large molded-in shelf.					
	350WHT	White	6 71031 00266 2	66	12.0		1,100.00

PREMIUM FIBERGLASS BATHTUB WALLS (Continued)

	Model No.	Colors	UPC	Lbs.	Cu. Ft.	Ship Via	List Price
	500 DURAWALL – Fits Mustee’s Topaz™ bathtub and any 30" x 60" bathtub. Fiberglass, adhesive mounts, smooth, semi-gloss finish. Three molded-in shelves.						
	500WHT	White	671031001818	63	9.6		\$992.00
	557 DURAWALL – Fits Mustee’s Topaz™ bathtub and any 30" x 60" or 32" x 60" bathtubs. Fiberglass, adhesive mounts, smooth, semi-gloss finish. Four molded-in shelves.						
	557WHT	White	671031003362	46	6.0		872.00

DELUXE THERMOPLASTIC BATHTUB WALLS

THERMOPLASTIC BATHTUB WALLS

	Model No.	Colors	UPC	Lbs.	Cu. Ft.	Ship Via	List Price
	56 DURAWALL – Fits Mustee Topaz™ bathtub or any whirlpool-sized bathtubs up to 42" x 72". Thermoplastic construction, adhesive mounts to drywall and like surfaces, six shelves.						
	56WHT	White	671031002884	28	6.8	UPS	618.00
	53 DURAWALL – Fits Mustee’s Topaz™ bathtub or any 30" x 60" bathtub. Thermoplastic construction, adhesive mounts to drywall and like surfaces, four shelves.						
	53WHT	White	671031004284	26	5.0	UPS	508.00
	950 DURAWALL – Fits Mustee’s Topaz™ bathtub or any 30" x 60" bathtub. Thermoplastic construction, adhesive mounts to drywall and like surfaces, four shelves.						
	950	White	671031002358	18	3.0	UPS	400.00

ACCESSORIES

	Part No.	Description	Material	UPC	Lbs.	Cu. Ft.	Ship Via	List Price
	300.600 DURATRIM™ FIBERGLASS WINDOW TRIM KIT – Fit windows up to 36" wide by 8" sill depth.							
	300.600W	White	Fiberglass	671031000606	9	0.5	UPS	300.00
	52.600W DURATRIM™ THERMOPLASTIC WINDOW TRIM KIT – Fit windows up to 36" wide by 8" sill depth.							
	52.600W	White	Thermoplastic	671031001856	3.1	0.5	UPS	165.00

FIBERGLASS BATHTUBS

See Topaz™ Bathtub Walls, page 14, for Tub/Shower combination.

T6030 TOPAZ™ FIBERGLASS BATHTUBS – Premium-molded fiberglass construction with structural underbody. Fits 30" x 60" alcove. Drain offset is 8½" x 15". Features slip-resistant bottom surface; RH and LH drain positions; deep, color-fast surface finish.

Model No.	Colors	Bathtub Size	Drain	UPC	Lbs.	Cu. Ft.	Ship Via	List Price
T6030L	White	30"x60"	Left Hand	6 71031 00411 6	55	21.0		\$542.00
T6030R	White	30"x60"	Right Hand	6 71031 00413 0	55	21.0		542.00

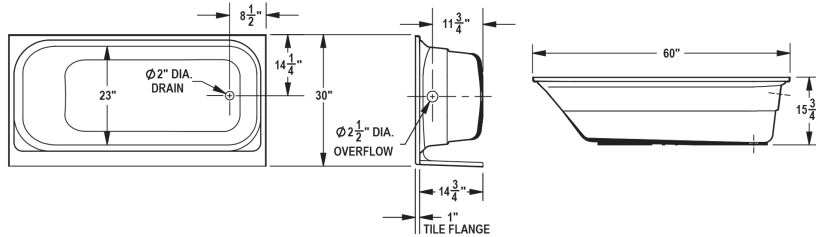

See Topaz™ Bathtub Walls, page 14, for Tub/Shower combination.

T6030L-AFD & T6030R-AFD TOPAZ™ ABOVE FLOOR DRAIN FIBERGLASS BATHTUBS – Premium-molded fiberglass construction. Fits 30" x 60" alcove. Drain offset is 8½" x 15". Raised bottom for above floor drain. Features slip-resistant bottom; RH and LH drain; color-fast finish.

T6030L-AFD	White	30"x60"	Left Hand	6 71031 00581 6	66	24.4		692.00
T6030R-AFD	White	30"x60"	Right Hand	6 71031 00580 9	66	24.4		692.00

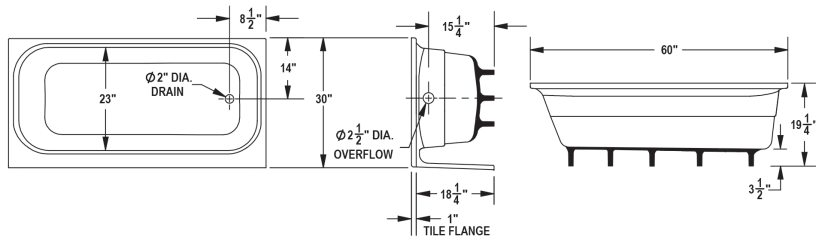

See Topaz™ Bathtub Walls, page 14, for Tub/Shower combination.

T6032 TOPAZ™ FIBERGLASS BATHTUBS – Premium-molded fiberglass construction with structural underbody. Fits 32" x 60" alcove. Drain offset is 8½" x 15". Features slip-resistant bottom surface; RH and LH drain positions; deep, color-fast surface finish.

T6032L	White	32"x60"	Left Hand	6 71031 00543 4	58	21.0		650.00
T6032R	White	32"x60"	Right Hand	6 71031 00542 7	58	21.0		650.00

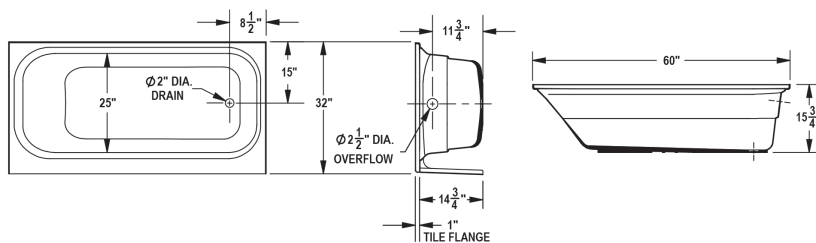

Mustee Fiberglass & Thermoplastic Bathtub Wall Surrounds – See pages 14 & 15.

FIBREGLASS SHOWER BASES

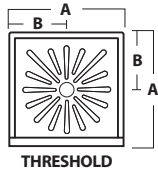

DURABASE® SQUARE, SINGLE THRESHOLD – Slip-resistant Starburst® floor design, connection to 2" DWV; integrally molded-in drain with seal and removable strainer.

Model No.	Colors	Size	A	B	C	D	UPC	Lbs.	Cu. Ft.	Ship Via	List Price
3232M	White	32"x32"	32"	16"	—	—	671031000781	25	5.0	UPS	\$332.00
3434M	White	34"x34"	34"	17"	—	—	671031001016	47	5.5		568.00
3636M	White	36"x36"	36"	18"	—	—	671031001481	34	6.3	UPS	395.00
4242M	White	42"x42"	42"	21"	—	—	671031003348	48	8.0		518.00
4848M	White	48"x48"	48"	24"	—	—	671031005236	52	13.4		865.00

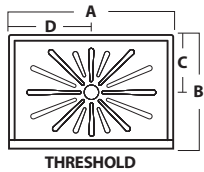

DURABASE® RECTANGULAR, SINGLE THRESHOLD – Slip-resistant Starburst® floor design, connection to 2" DWV; integrally molded-in drain with seal and removable strainer.

3248M	White	32"x48"	48"	32"	16"	24"	671031000859	45	8.4		452.00
3254M	White	32"x54"	54"	32"	16"	27"	671031000910	50	9.8		588.00
3260M	White	32"x60"	60"	32"	16"	30"	671031000941	57	11.3		612.00
3442M	White	34"x42"	42"	34"	17"	21"	671031001054	40	8.3		442.00
3448M	White	34"x48"	48"	34"	17"	24"	671031001122	47	9.0		465.00
3454M	White	34"x54"	54"	34"	17"	27"	671031001184	46	9.3		538.00
3460M	White	34"x60"	60"	34"	17"	30"	671031001238	46	12.0		598.00
3642M	White	36"x42"	42"	36"	17"	21"	671031005199	45	9.0		480.00
3648M	White	36"x48"	48"	36"	18"	24"	671031005052	41	9.4		496.00
3660M	White	36"x60"	60"	36"	18"	24"	671031005069	51	12.3		642.00
4236M*	White	42"x36"	36"	42"	21"	18"	671031003447	47	9.0		465.00
* Threshold on 36" side											
4248M	White	42"x48"	48"	42"	21"	24"	671031005489	53	11.5		810.00
4260M	White	42"x60"	60"	42"	21"	30"	671031005250	67	14.0		885.00

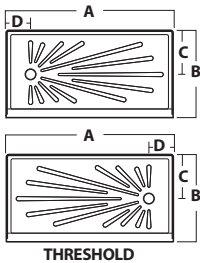

DURABASE® (BATHTUB REPLACEMENT) – Slip-resistant Starburst® floor design. Drain not included.

3060L	White	30"x60"	60"	30"	15"	30"	Left Hand	671031003577	55	7.0	540.00
3060R	White	30"x60"	60"	30"	15"	30"	Right Hand	671031003553	55	7.0	540.00

Optional Drains, Drain Seals and Strainers for DURABASE® Shower Floors – See pages 18 & 19.

FIBREGLASS SHOWER BASES (Continued)

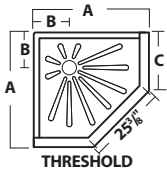

DURABASE® NEO-ANGLE, CORNER THRESHOLD – Fiberglass construction with slip-resistant Starburst® floor design, connection to 2" DWV; integrally molded-in drain with seal and removable strainer.

Model No.	Colors	Size	A	B	C	D	UPC	Lbs.	Cu. Ft.	Ship Via	List Price
3636CM	White	36"x36"	36"	12"	18"		6 71031 00140 5	34	7.3	UPS	\$418.00
3838CM	White	38"x38"	38"	12"	20"		6 71031 00160 3	36	6.7		465.00
4242CM	White	42"x42"	42"	12"	24"		6 71031 00318 8	48	8.0		684.00

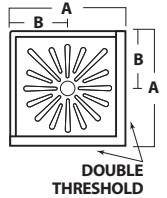

DURABASE® CORNER, DOUBLE THRESHOLD – Fiberglass construction with slip-resistant Starburst® floor design, connection to 2" DWV; integrally molded-in drain with seal and removable strainer.

3434DTM	White	34"x34"	34"	17"			6 71031 00098 9	47	5.5		450.00
3636DTM	White	36"x36"	36"	18"			6 71031 00144 3	34	5.0	UPS	465.00

ACCESSORIES

Model No.	Description	UPC	Lbs.	Cu. Ft.	Ship Via	List Price
-----------	-------------	-----	------	---------	----------	------------

DRAIN ASSEMBLY – 2"

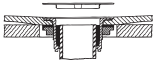

42.317A	PVC drain with seal for 2" iron, PVC and ABS pipe, strainer	6 71031 00167 2	—	—	UPS	45.00
---------	---	-----------------	---	---	-----	-------

Optional Drain Seals – See page 19.



42.400A	2" PVC for side outlet	6 71031 00488 8	—	—	UPS	75.00
---------	------------------------	-----------------	---	---	-----	-------

DRAIN ASSEMBLY – 1 1/2"



82.400A	1 1/2" PVC for side outlet	6 71031 00220 4	—	—	UPS	75.00
---------	----------------------------	-----------------	---	---	-----	-------

DRAIN SEAL – for "M" DURABASE® (molded drain)

32.401	Use on 2" PVC, ABS or Iron pipe	6 71031 00306 5	—	—	UPS	24.00
32.404	Use on 2" copper	6 71031 00313 3	—	—	UPS	24.00
32.405	Use on 1 1/2" PVC and ABS	6 71031 00397 3	—	—	UPS	24.00

STRAINER





42.322	Plastic/white	6 71031 00533 5	—	—	UPS	23.00
42.326	Plastic/chrome plated	6 71031 00493 2	—	—	UPS	45.00
42.327	Plastic/gold plated	6 71031 00494 9	—	—	UPS	45.00

60.320A GAPSEAL-PRO – Flexible, adhesive-backed PVC strip seals the gap between drywall & like surfaces and the tile flange on shower floors or bathtubs.

60.320A		6 71031 00496 3	—	—	UPS	50.00
---------	--	-----------------	---	---	-----	-------

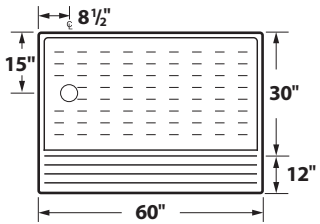
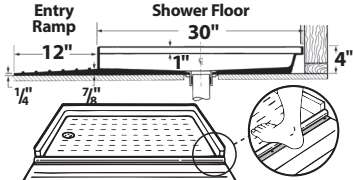
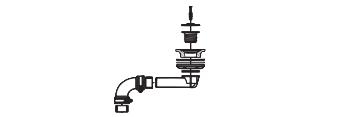
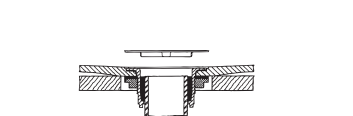
EASY-ACCESS FIBERGLASS SHOWER FLOORS 

	Model No.	Colors	Size	UPC	Lbs.	Cu. Ft.	Ship Via	List Price
	360L/R BARRIER-FREE SHOWER FLOOR – Fits 30" x 60" alcove. Drain offset is 8½" x 15". Features slip-resistant floor; RH or LH drain position. Entry ramp and drain sold separately.							
	FLOOR							
	360L	White	30"x60"	6 71031 00273 0	50	5.6		722.00
	360R	White	30"x60"	6 71031 00271 6	50	5.6		722.00
ACCESSORIES								
	ENTRY RAMP							
	360.100	White	12"x60"	6 71031 00275 4	25	0.7	UPS	360.00
	CONTINUOUS WATER BARRIER KIT							
	360.210	Continuous Water Barrier		6 71031 00479 6	0.5	—	UPS	89.00
	SHOWER TUB™ DRAIN KIT – ties into existing tub waste.							
	60.300A	White	3060R, 3060L, 360R, 360L	6 71031 00392 8	—	—	UPS	123.00
	DRAIN ASSEMBLY – 2"							
	42.317A	PVC drain with seal for 2" iron, PVC and ABS pipe, strainer		6 71031 00167 2	—	—	UPS	45.00
	42.320	Optional drain for 2" copper (DWV)		6 71031 00309 6	—	—	UPS	23.00
	42.321	Optional drain seal for 2" soil pipe (SW)		6 71031 00495 6	—	—	UPS	23.00
	42.330	Optional drain seal for 1½" pipe PVC		6 71031 00537 3	—	—	UPS	23.00

EASY-ACCESS FIBERGLASS SHOWER FLOORS  (Continued)

Model No.	Colors	Size	UPC	Lbs.	Cu. Ft.	Ship Via	List Price
-----------	--------	------	-----	------	---------	----------	------------

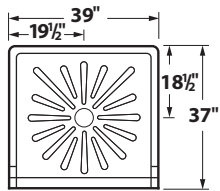

3739 TRANSFER SHOWER FLOOR  – Fits 39" x 37" alcove. Features slip-resistant Starburst® floor; center drain position; connection to 2" DWV; integrally molded-in drain with seal and removable strainer.



3739	White	37"x39"	6 71031 00353 9	35	6.1	UPS	\$490.00
------	-------	---------	-----------------	----	-----	-----	----------

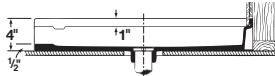

ACCESSORIES

CONTINUOUS WATER BARRIER KIT (See below.)

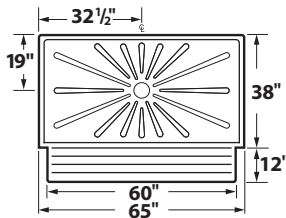

3865 BARRIER-FREE SHOWER FLOOR  – Fits 38" x 65" alcove. Features slip-resistant Starburst® floor. Entry ramp and drain sold separately.



FLOOR							
3865	White	38"x65"	6 71031 00430 7	64	6.3		1,100.00

Shown with Entry Ramp

ACCESSORIES

ENTRY RAMP

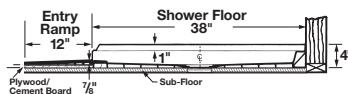

360.100	White	12"x60"	6 71031 00275 4	25	0.7	UPS	360.00
---------	-------	---------	-----------------	----	-----	-----	--------



CONTINUOUS WATER BARRIER KIT



360.210	Continuous Water Barrier		6 71031 00479 6	0.5	—	UPS	89.00
---------	--------------------------	--	-----------------	-----	---	-----	-------

Optional Drains, Drain Seals and Strainers – See pages 18 & 19.

PREMIUM FIBERGLASS SHOWER WALLS

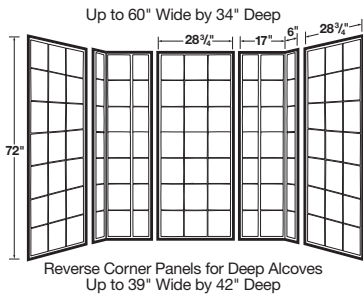

Model No.	Colors	Fits SHOWERBASE	UPC	Lbs.	Cu. Ft.	Ship Via	List Price
-----------	--------	-----------------	-----	------	---------	----------	------------

572T VARISTONE™ SHOWER WALL – Tall 72" high with embossed tile pattern. Fits all DURABASE® Shower Floors and alcoves up to 60" wide by 34" deep or 39" wide by 42" deep. Fiberglass construction, adhesive mounts to drywall and like surfaces.

572TWHT	White	All Square & Rectangular sizes	6 71031 00420 8	110	9.9		\$1,850.00
---------	-------	--------------------------------	-----------------	-----	-----	--	------------

(See bottom of page for Varistone™ shelves.)

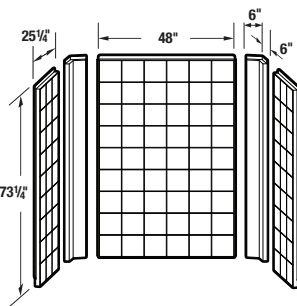

760T-30WHT DURAWALL® SQUARE & RECTANGULAR – Features embossed tile pattern or side and back panels. Fits Mustee's 3060/360 Shower Floors. Fiberglass construction, tongue-and-groove panels create watertight seal. Mounts direct-to-studs.

760T-30WHT	White	3060R, 3060L, 360R, 360L	—	95.5	15.8		1,670.00
------------	-------	--------------------------	---	------	------	--	----------

Ships in three (3) cartons.

760T.1	Back Panels		6 71031 00483 3	46	7.8		600.00
760T.2	Side Panels (2)		6 71031 00485 7	42	6.0		600.00
760T.6	Corners (2)		6 71031 00484 0	18	2.8		380.00

(See bottom of page for Varistone™ shelves.)

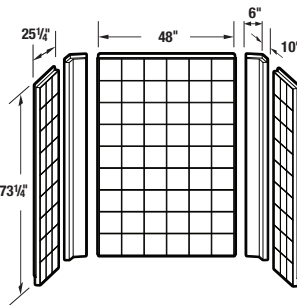

760T-34WHT DURAWALL® SQUARE & RECTANGULAR – Features embossed tile pattern or side and back panels. Fits Mustee's 3460M Shower Floor. Fiberglass construction, tongue-and-groove panels create watertight seal. Mounts direct-to-studs.

760T-34WHT	White	3460M	—	95.5	15.8		1,800.00
------------	-------	-------	---	------	------	--	----------

Ships in three (3) cartons.

760T.1	Back Panels		6 71031 00483 3	46	7.8		600.00
760T.2	Side Panels (2)		6 71031 00485 7	42	6.0		600.00
760T.10	Corners (2)		6 71031 00518 2	39	4.4		650.00

(See bottom of page for Varistone™ shelves.)

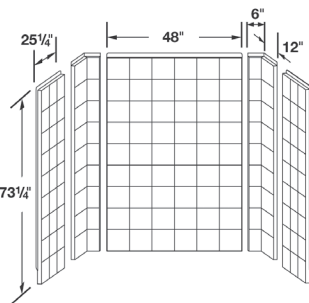

760T-36WHT DURAWALL® SQUARE & RECTANGULAR – Features embossed tile pattern or side and back panels. Fits Mustee's 3660M Shower Floor. Fiberglass construction, tongue-and-groove panels create watertight seal. Mounts direct-to-studs.

760T-36WHT	White	3660M	—	116	19.1		1,800.00
------------	-------	-------	---	-----	------	--	----------

Ships in three (3) cartons.

760T.1	Back Panels		6 71031 00483 3	46	7.8		600.00
760T.2	Side Panels (2)		6 71031 00485 7	42	6.0		600.00
760T.12	Corners (2)		6 71031 00556 4	28	5.3		560.00

(See bottom of page for Varistone™ shelves.)

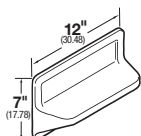

ACCESSORIES



572.300 VARISTONE™ SHELVES – White 7" High

			6 71031 00385 0	2.5	0.2		85.00
--	--	--	-----------------	-----	-----	--	-------

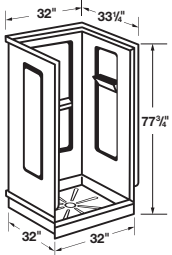
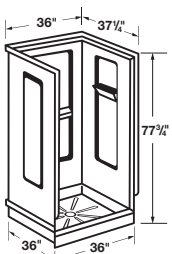
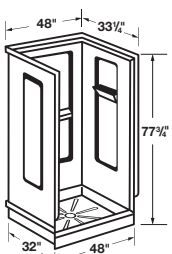
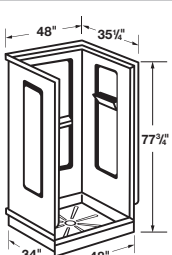
PREMIUM FIBERGLASS SHOWER WALLS (Continued)

	Model No.	Colors	Fits SHOWERBASE	UPC	Lbs.	Cu. Ft.	Ship Via	List Price
 <p>Shown with Shower Floor</p>	732 DURAWALL[®] SQUARE – Fits Mustee’s DURABASE [®] 3232M. Mounts direct-to-studs; smooth, glossy finish; three shelves. New smooth side walls.							
	732SWHT	White	3232M	6 71031 00248 8	75	5.0		\$1,125.00
 <p>Shown with Shower Floor</p>	736 DURAWALL[®] SQUARE – Fits Mustee’s DURABASE [®] 3636M. Mounts direct-to-studs; smooth, glossy finish; three shelves. New smooth side walls.							
	736SWHT	White	3636M	6 71031 00209 9	78	11.7		1,230.00
 <p>Shown with Shower Floor</p>	748-32 DURAWALL[®] SQUARE – Fits Mustee’s DURABASE [®] 3248M. Mounts direct-to-studs; smooth, glossy finish; three shelves. New smooth side walls.							
	748-32SWHT	White	3248M	—	90	9.0		1,278.00
	Ships in two (2) cartons.							
	700.2SW	Side Panels (2)		6 71031 00328 7	45	7.9		620.00
	748.32W	Back Panels		6 71031 00341 6	45	9.1		500.00
 <p>Shown with Shower Floor</p>	748-34 DURAWALL[®] RECTANGULAR – Fits Mustee’s DURABASE [®] 3448M. Mounts direct-to-studs; smooth, glossy finish; three shelves. New smooth side walls.							
	748-34SWHT	White	3448M	—	90	9.0		1,278.00
	Ships in two (2) cartons.							
	700.2SW	Side Panels (2)		6 71031 00328 7	45	7.9		620.00
	748.34W	Back Panels		6 71031 00343 0	45	9.1		500.00
  <p>Shown with Shower Floor</p>	736C DURAWALL[®] NEO-ANGLE/CORNER – Fits Mustee’s DURABASE [®] 36” Neo-Angle or Double-Threshold floors. Mounts direct-to-studs; smooth, glossy finish; two shelves.							
	736CWHT	White	—	6 71031 00207 5	58	9.5		1,050.00

PREMIUM FIBERGLASS SHOWER WALLS (Continued)

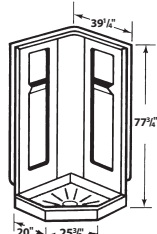

Shown with Shower Floor

Model No.	Colors	Fits SHOWERBASE	UPC	Lbs.	Cu. Ft.	Ship Via	List Price
738C DURAWALL® NEO-ANGLE/CORNER – Fits Mustee’s DURABASE® 3838CM. Fiberglass construction, tongue-and-groove panels create watertight seal. Mounts direct-to-studs; smooth, colorfast glossy finish; two molded-in shelves.							
738CWHT	White	3838CM	6 71031 00245 7	61	13.5		\$1,150.00

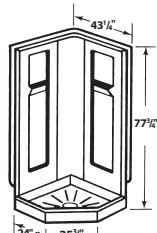

Shown with Shower Floor

742C DURAWALL® NEO-ANGLE/CORNER – Fits Mustee’s DURABASE® 4242CM. Fiberglass construction, tongue-and-groove panels create watertight seal. Mounts direct-to-studs; smooth, colorfast glossy finish; two molded-in shelves.							
742CWHT	White	4242CM	—	70	8.0		1,450.00
Ships in two (2) cartons.							
700.2W	Side Panels (2)		6 71031 00328 7	45	7.9		620.00
742.1W	Corner Panels		6 71031 00330 0	20	8.8		742.00

THERMOPLASTIC SHOWER WALLS

THERMOPLASTIC SHOWER WALLS

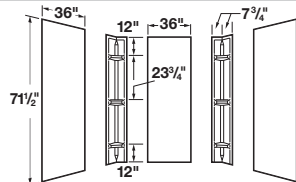

Model No.	Colors	UPC	Lbs.	Cu. Ft.	Ship Via	List Price
247 DURAWALL® SQUARE & RECTANGULAR – Fits alcoves up to 48" wide by 42" deep; thermoplastic construction; seamless corner panels to overlap trimmable side and back panels. Adhesive mounts to drywall and like surfaces; Smooth, colorfast glossy finish; six molded-in shelves						
247WHT	White	6 71031 00048 4	35	9.1		665.00

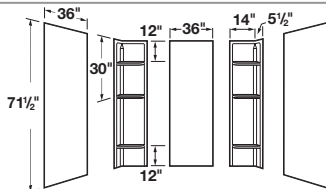

260 DURAWALL® SQUARE & RECTANGULAR – Fits alcoves up to 60" wide by 40" deep; thermoplastic construction. Seamless corner panels to overlap trimmable side and back panels. Adhesive mounts to drywall and like surfaces. Smooth, colorfast glossy finish; six molded-in shelves.						
260WHT	White	6 71031 00053 8	40	9.0		940.00

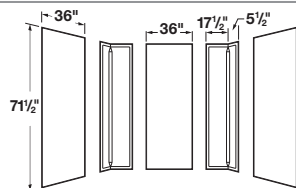

265 DURAWALL® SQUARE & RECTANGULAR – Fits alcoves up to 71" wide by 41 1/2" deep; thermoplastic construction. Seamless corner panels to overlap trimmable side and back panels. Adhesive mounts to drywall and like surfaces. Smooth, colorfast glossy finish.						
265WHT	White	6 71031 00478 9	43	9.0		940.00

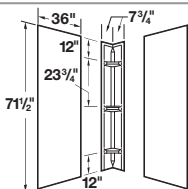

237 DURAWALL® NEO-ANGLE/CORNER – Fits corners up to 42" deep; thermoplastic construction. Seamless corner panels to overlap trimmable side panels; adhesive mounts to drywall and like surfaces. Smooth, colorfast glossy finish; three molded-in shelves						
237WHT	White	6 71031 00039 2	26	8.2		498.00

SHOWER ENCLOSURES

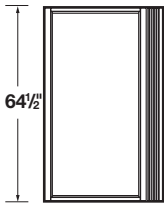
Model No.	Size/ Opening	Glass	Finish	UPC	Lbs.	Cu. Ft.	Ship Via	List Price
	STYLEMATE® PIVOT DOORS – Clear tempered safety glass; aluminum construction; LH or RH opening, adjustable; pull handle with magnetic catch.							
	32.705	Fits 29" to 31"	Clear	Bright Silver	6 71031 00462 8	28	3.1	\$695.00
	32.706	Fits 29" to 31"	Clear	Black Bronze	6 71031 00463 5	29	3.1	900.00
	36.403	Fits 34" to 35 1/2"	Clear	Bright Silver	6 71031 00464 2	33	4.8	760.00
	36.404	Fits 34" to 35 1/2"	Clear	Black Bronze	6 71031 00465 9	34	4.8	748.00

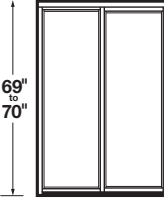
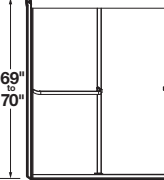
	STYLEMATE® BY-PASS DOORS – Framed or frameless styles; clear tempered safety glass; aluminum construction; adjustable.							
	FRAME							
	48.403	48"	Clear	Bright Silver	6 71031 00466 6	58	4.8	1,650.00
	FRAMELESS DESIGN							
	48.406	48"	Clear	Bright Silver	6 71031 00469 7	61	4.8	1,310.00
48.407	48"	Clear	Brushed Nickel	6 71031 00470 3	61	4.8	1,310.00	
48.408	48"	Clear	Black Bronze	6 71031 00471 0	61	4.8	1,310.00	
 <p>Frameless design</p>	FRAME							
	60.403	60"	Clear	Bright Silver	6 71031 00472 7	72	4.8	1,450.00
	FRAMELESS DESIGN							
	60.406	60"	Clear	Bright Silver	6 71031 00475 8	86	4.8	1,560.00
	60.407	60"	Clear	Brushed Nickel	6 71031 00476 5	86	4.8	1,560.00
60.408	60"	Clear	Black Bronze	6 71031 00477 2	86	5.4	1,560.00	

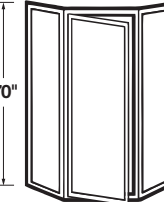
	STYLEMATE® NEO-ANGLE DOORS – LH or RH pivot door; clear or obscure tempered safety glass; adjustable; aluminum construction; pull handle with magnetic catch.							
	36.750	36" Neo	Obscure	Bright Silver	6 71031 00261 7	64	5.6	1,250.00
	36.761	36" Neo	Clear	Bright Silver	6 71031 00453 6	66	4.8	1,250.00
	36.762	36" Neo	Clear	Brushed Nickel	6 71031 00454 3	66	4.8	1,400.00
	36.763	36" Neo	Clear	Black Bronze	6 71031 00455 0	66	4.8	1,400.00
	38.750	38" Neo	Obscure	Bright Silver	6 71031 00269 3	68	5.6	1,250.00
	38.751	38" Neo	Clear	Bright Silver	6 71031 00456 7	68	4.8	1,350.00
	38.752	38" Neo	Clear	Brushed Nickel	6 71031 00457 4	68	4.8	1,650.00
	38.753	38" Neo	Clear	Black Bronze	6 71031 00458 1	68	4.8	1,650.00
	42.751	42" Neo	Clear	Bright Silver	6 71031 00459 8	71	4.8	1,500.00
	42.752	42" Neo	Clear	Brushed Nickel	6 71031 00460 4	71	4.8	1,800.00
	42.753	42" Neo	Clear	Black Bronze	6 71031 00461 1	71	4.8	1,800.00

WASHER & WATER HEATER PANS

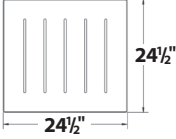
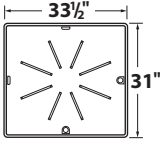
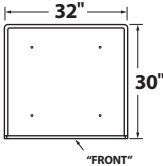
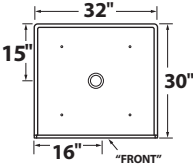
	Model No.	Size LxW*	Packing	Drain Location	UPC	Lbs.	Cu. Ft.	Ship Via	List Price
	95 DURAPAN	<p>– Great for condos, apartments, and high-rises. This high strength, impact-resistant molded pan features a 2¼" tall curb with a 1" 90 degree PVC elbow drain fitting for drainage. Measures (inside): 24" x 24" x 2".</p>							
	95	24½"x24½"		Side	6 71031 00524 3	5	2.1	UPS	\$192.00
	96 DURAPAN	<p>– Prevent floor damage. Co-Polypure thermoplastic. Outlet fitting (included) can be installed on bottom or side to connect with 1" piping to drain. Measures (inside): 28" x 31½" x 2".</p>							
	96	31"x33½"		Side or Bottom	6 71031 00381 2	7.5	1.5	UPS	128.00
	98 DURAPAN	<p>– Prevent floor damage. High strength fiberglass. Outlet fitting (included) can be installed on bottom or side to connect with 1" piping to drain. Removable front. Measures (inside): 28" x 29" x 2".</p>							
	98	30"x32"		Side	6 71031 00299 0	21	2.0	UPS	238.00
	99 DURAPAN	<p>– Prevent floor damage. High strength fiberglass. Center drain installs directly over 2" ABS, PVC (Sch. 40) or CI drain pipe. Removable front. Measures (inside): 28" x 29" x 2".</p>							
	99	30"x32"		Center	6 71031 00281 5	21	2.0	UPS	249.00

* L=Length (front to back); W=Width (left to right)

MOP SERVICE BASINS

Model No.	Size	Drain	UPC	Lbs.	Cu. Ft.	Ship Via	List Price
-----------	------	-------	-----	------	---------	----------	------------

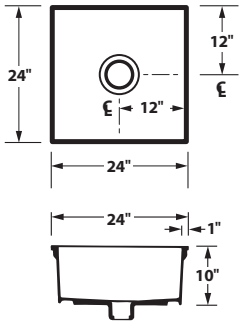

63M MOP SERVICE BASIN – DURASTONE® fiberglass construction for high impact resistance. Features extra-deep 10" side walls; integral molded-in drain with seal for 3" ABS, PVC (Sch. 80) or cast iron.

63M	24"x24"x10"	3"	6 71031 00189 4	32	4.2	UPS	\$400.00
-----	-------------	----	-----------------	----	-----	-----	----------

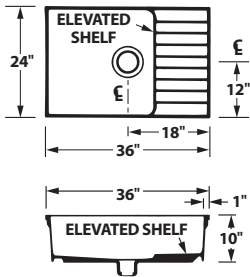

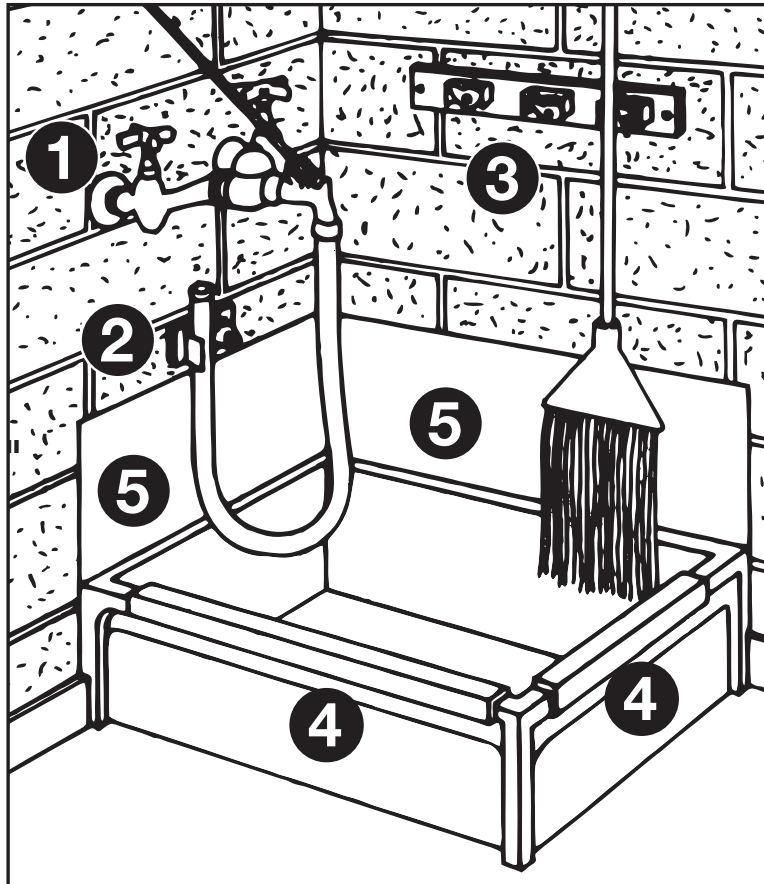

65M MOP SERVICE BASIN – DURASTONE® fiberglass construction for high impact resistance. Features molded-in elevated shelf; extra-deep 10" side walls; integral molded-in drain with seal for 3" ABS, PVC (Sch. 80) or cast iron.

65M	24"x36"x10"	3"	6 71031 00194 8	43	6.3		445.00
-----	-------------	----	-----------------	----	-----	--	--------

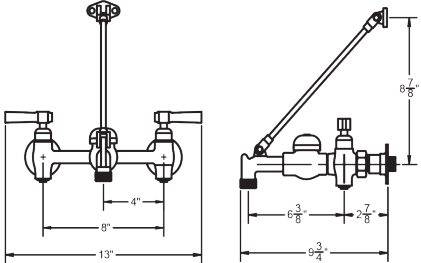

MOP SERVICE BASIN ACCESSORIES

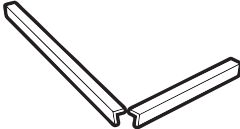
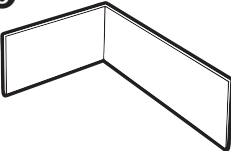
ACCESSORIES	Model No.	Description	UPC	Ship Via	List Price
1 	63.600A	MOP SERVICE FAUCET Chrome plated brass body with vacuum breaker, 8" centers, reinforcing bracket, pail hook	671031 00277 8	UPS	\$230.00
	65.700	HOSE & BRACKET 32" long, 5/8" diameter, heavy-duty hose	671031 00196 2	UPS	88.00
3 	65.600	MOP HANGER Stainless steel, wall mounted, three spring-loaded mop handle holders	671031 00195 5	UPS	140.00
	4 	63.401	BUMPER GUARD VINYL 20 3/4" long white PVC, fits models 63M and 65M	671031 00290 7	UPS
65.403		32 3/4" long white PVC, fits model 65M	671031 00291 4	UPS	80.00
63.403		BUMPER GUARD STAINLESS STEEL 20 3/4" long stainless steel, fits model 63M and 65M	671031 00409 3	UPS	62.00
65.404		32 3/4" long stainless steel, fits model 65M	671031 00410 3	UPS	84.00
5 	67.2424	DURAGUARD™ WALL GUARD – Stainless Steel Two panels and 1 bracket for 24"x24" corner	671031 00293 8	UPS	262.00
	67.2436	Two panels and 1 bracket for 24"x36" corner	671031 00294 5	UPS	268.00
	65.308	DRAIN SEAL For 2" PVC, ABS and iron	671031 00303 4	UPS	26.00
	65.309	For 3" PVC, ABS and iron, included with mop basin	671031 00304 1	UPS	26.00
	65.311	For 3" soil pipe (no hub)	671031 00305 8	UPS	26.00

SHOWER & BATH ENSEMBLES

Product guide to create your Mustee Shower or Bath Ensemble. All product options are arranged by size and include all product combinations to build your ensemble. Follow these easy steps.

Step 1. Determine Alcove Size

Measure the alcove where your new shower or bath will be installed.

Step 2. Find Right Combination

Refer to Table of Contents to locate the size of shower or bath ensemble.

Step 3. Select Your Ensemble

Select the shower or bathtub combination that fits your installation and style.

Step 3. Select Accessories

Available accessories for each ensemble are included on each page.

Sizing and configuration

The combinations of shower walls, enclosures and floors... or bathtub walls and bathtubs

Accessories that fit this shower or bathtub ensemble

TABLE OF CONTENTS SHOWER & BATH ENSEMBLES

SQUARE SHOWER ENSEMBLES

32" x 32"	29
36" x 36"	29
42" x 42"	29

RECTANGULAR SHOWER ENSEMBLES

30" x 60"	30
32" x 48" & 34" x 48"	31
32" x 60", 34" x 60" & 36" x 60"	32
Various Sizes.....	32

ADA EASY ACCESS SHOWER ENSEMBLES

30" x 60"	33
37" x 39"	34
38" x 65"	35

NEO-ANGLE SHOWER ENSEMBLES

36"	36
38"	36
42"	36

BATHTUB ENSEMBLES

30" x 60" Direct-to-Stud.....	37
32" x 60" Direct-to-Stud.....	37
Adhesive-Mount	38

32" x 32" SQUARE SHOWER ENSEMBLES

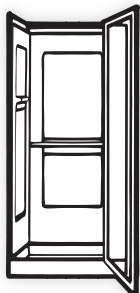

Model 732 shown

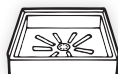

Model No.	Material / Color / Mount	UPC	Lbs.	Ship Via	List Price
-----------	--------------------------	-----	------	----------	------------

DURAWALL® & VARISTONE™ SQUARE SHOWER WALLS

247WHT	Thermoplastic / White / Adhesive	6 71031 00048 4	35		\$665.00
260WHT	Thermoplastic / White / Adhesive	6 71031 00053 8	40		940.00
265WHT	Thermoplastic / White / Adhesive	6 71031 00478 9	43		940.00
732SWHT	Fiberglass / White / Direct to Stud	6 71031 00248 8	75		1,125.00
572TWHT	Varistone™ / White / Adhesive	6 71031 00420 8	110		1,850.00

STYLEMATE® PIVOT DOORS

32.705	Bright Silver / Clear Safety Glass	6 71031 00462 8	28		695.00
32.706	Black Bronze / Clear Safety Glass	6 71031 00463 5	29		900.00

DURABASE® SQUARE SHOWER FLOORS

3232M	Fiberglass / White	6 71031 00078 1	25		332.00
-------	--------------------	-----------------	----	--	--------

36" x 36" SQUARE SHOWER ENSEMBLES

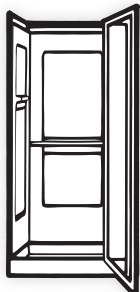

Model 736 shown

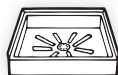

DURAWALL® & VARISTONE™ SQUARE SHOWER WALLS

247WHT	Thermoplastic / White / Adhesive	6 71031 00048 4	35		\$665.00
260WHT	Thermoplastic / White / Adhesive	6 71031 00053 8	40		940.00
265WHT	Thermoplastic / White / Adhesive	6 71031 00478 9	43		940.00
736SWHT	Fiberglass / White / Direct to Stud	6 71031 00209 9	78		1,230.00
572TWHT	Varistone™ / White / Adhesive	6 71031 00420 8	110		1,850.00

STYLEMATE® PIVOT DOORS

36.403	Bright Silver / Clear Safety Glass	6 71031 00464 2	33		760.00
36.404	Black Bronze / Clear Safety Glass	6 71031 00465 9	34		748.00

DURABASE® SQUARE SHOWER FLOORS

3636M	Fiberglass / White	6 71031 00148 1	34		395.00
-------	--------------------	-----------------	----	--	--------

42" x 42" SQUARE SHOWER ENSEMBLES

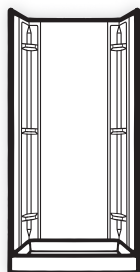

Model 247 shown

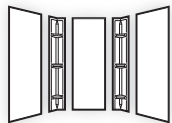

Model 247 shown

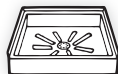

DURAWALL® SQUARE SHOWER WALLS

247WHT	Thermoplastic / White / Adhesive	6 71031 00048 4	35		665.00
--------	----------------------------------	-----------------	----	--	--------

DURABASE® SQUARE SHOWER FLOORS

4242M	Fiberglass / White	6 71031 00334 8	48		518.00
-------	--------------------	-----------------	----	--	--------

For a complete list of Grab Bars and Fold-Down Seats, see pages 42–47.

30" x 60" RECTANGULAR SHOWER ENSEMBLES

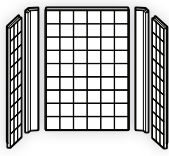
Model No.	Material / Color / Mount	UPC	Lbs.	Ship Via	List Price
DURAWALL® & VARISTONE™ RECTANGULAR SHOWER WALLS					
 Model 760T-30 shown	572TWH Varistone™ / White / Adhesive	671031 00420 8	110		\$1,850.00
	265WHT Thermoplastic / White / Adhesive	671031 00478 9	43		940.00
	260WHT Thermoplastic / White / Adhesive	671031 00053 8	40		940.00
	760T-30WHT Fiberglass / White / Direct to Stud	—	95.5		1,670.00

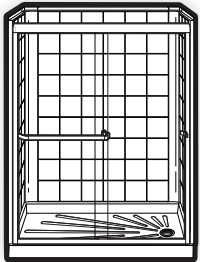

STYLEMATE® BY-PASS DOORS

FRAMED DESIGN

60.403 Bright Silver / Clear Safety Glass 671031 00472 7 72 1,450.00

FRAMELESS DESIGN

60.406 Bright Silver / Clear Safety Glass 671031 00475 8 86 1,560.00

60.407 Brushed Nickel / Clear Safety Glass 671031 00476 5 86 1,560.00

60.408 Black Bronze / Clear Safety Glass 671031 00477 2 86 1,560.00

DURABASE® RECTANGULAR SHOWER FLOORS

SHOWERTUB®



3060L Fiberglass / White 671031 00357 7 55 540.00



3060R Fiberglass / White 671031 00355 3 55 540.00

ACCESSORIES



FOLD-DOWN SEATS – Stainless steel frame. White cushion filled with high density foam.

62-PA2601 Rectangular Wall Mount / 26"x14.5" 19 UPS 480.00

See additional Fold-Down Shower Seats that can be used with this ensemble on page 45.

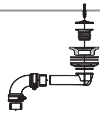

SHOWER TUB™ DRAIN KIT – ties into existing tub waste.

60.300A White – fits models: 3060R, 3060L, 360R, 360L 671031 00392 8 — UPS 123.00

Optional Drains, Drain Seals and Strainers – See pages 18 & 19.

32" x 48" & 34" x 48" RECTANGULAR SHOWER ENSEMBLES

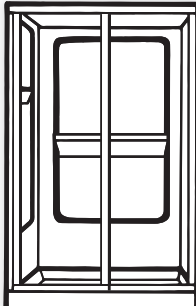
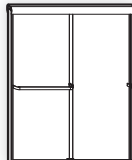
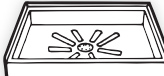
Model No.	Material / Color / Mount	UPC	Lbs.	Ship Via	List Price
DURAWALL® & VARISTONE™ RECTANGULAR SHOWER WALLS					
	247WHT	Thermoplastic / White / Adhesive	671031 00048 4	35	\$665.00
	260WHT	Thermoplastic / White / Adhesive	671031 00053 8	40	940.00
	265WHT	Thermoplastic / White / Adhesive	671031 00478 9	43	940.00
	748-32SWHT	Fiberglass / White / Direct to Stud (Fits 3248M only)	—	90	1,278.00
	748-34SWHT	Fiberglass / White / Direct to Stud (Fits 3448M only)	—	90	1,278.00
	572TWHT	Varistone™ / White / Adhesive	671031 00420 8	110	1,850.00
	STYLEMATE® BY-PASS DOORS				
	FRAMED DESIGN				
	48.403	Bright Silver / Clear Safety Glass	671031 00466 6	58	1,650.00
	FRAMELESS DESIGN				
	48.406	Bright Silver / Clear Safety Glass	671031 00469 7	61	1,310.00
	48.407	Brushed Nickel / Clear Safety Glass	671031 00470 3	61	1,310.00
	48.408	Black Bronze / Clear Safety Glass	671031 00471 0	61	1,310.00
	DURABASE® RECTANGULAR SHOWER FLOORS				
	3248M	Fiberglass / White	671031 00085 9	45	452.00
	3448M	Fiberglass / White	671031 00112 2	47	465.00

Model 748-32 shown

32" x 60", 34" x 60" & 36" x 60" RECTANGULAR SHOWERS – ADHESIVE MOUNT & DIRECT TO STUD

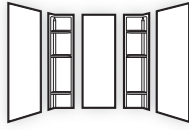
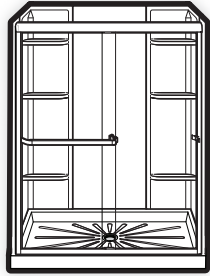

Model 260 shown

Model No.	Material / Color / Mount	UPC	Lbs.	Ship Via	List Price
DURAWALL RECTANGULAR SHOWER WALLS					
572TWH	Varistone™ / White / Adhesive	671031 00420 8	110		\$1,850.00
260WHT	Thermoplastic / White / Adhesive	671031 00053 8	40		940.00
265WHT	Thermoplastic / White / Adhesive	671031 00478 9	43		940.00
760T-34WHT	Fiberglass / White / Direct to Stud (Fits 3460M only)	—	95.5		1,800.00
760T-36WHT	Fiberglass / White / Direct to Stud (Fits 3660M only)	—	116		1,800.00

STYLEMATE® BY-PASS DOORS

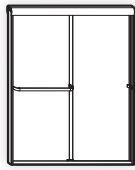

Model No.	Material / Color / Mount	UPC	Lbs.	Ship Via	List Price
FRAMED DESIGN					
60.403	Bright Silver / Clear Safety Glass	671031 00472 7	72		1,450.00
FRAMELESS DESIGN					
60.406	Bright Silver / Clear Safety Glass	671031 00475 8	86		1,560.00
60.407	Brushed Nickel / Clear Safety Glass	671031 00476 5	86		1,560.00
60.408	Black Bronze / Clear Safety Glass	671031 00477 2	86		1,560.00



DURABASE® RECTANGULAR SHOWER FLOORS

Model No.	Material / Color / Mount	UPC	Lbs.	Ship Via	List Price
3260M	Fiberglass / White	671031 00094 1	57		612.00
3460M	Fiberglass / White	671031 00123 8	46		598.00
3660M	Fiberglass / White	671031 00506 9	51		642.00

VARIOUS SIZES RECTANGULAR SHOWER ENSEMBLES – ADHESIVE MOUNT



Model 265 shown

DURAWALL RECTANGULAR SHOWER WALLS

Model No.	Material / Color / Mount	UPC	Lbs.	Ship Via	List Price
260WHT	Thermoplastic / White / Adhesive	671031 00053 8	40		940.00
265WHT	Thermoplastic / White / Adhesive	671031 00478 9	43		940.00



DURABASE® RECTANGULAR SHOWER FLOORS

Model No.	Material / Color / Mount	UPC	Lbs.	Ship Via	List Price
3254M	Fiberglass / White	671031 00091 0	50		588.00
3260M	Fiberglass / White	671031 00094 1	57		612.00
3442M	Fiberglass / White	671031 00105 4	40		442.00
3454M	Fiberglass / White	671031 00118 4	46		538.00
3460M	Fiberglass / White	671031 00123 8	46		598.00
3642M	Fiberglass / White	671031 00519 9	45		480.00
3648M	Fiberglass / White	671031 00505 2	41		496.00
3660M	Fiberglass / White	671031 00506 9	51		642.00
4236M	Fiberglass / White	671031 00344 7	47		465.00

For a complete list of Grab Bars and Fold-Down Seats, see pages 42–47.

30" x 60" BARRIER-FREE SHOWER ENSEMBLES

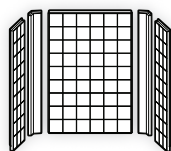
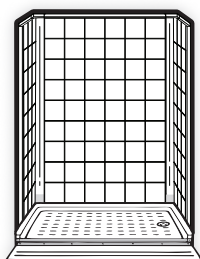

Model 760T-30 shown

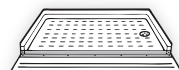

Shown with optional ramp.

Model No.	Material / Color / Mount	UPC	Lbs.	Ship Via	List Price
DURAWALL® & VARISTONE™ RECTANGULAR SHOWER WALLS					
572TWHT	Varistone™ / White / Adhesive	6 71031 00420 8	110		\$1,850.00
260WHT	Thermoplastic / White / Adhesive	6 71031 00053 8	40		940.00
265WHT	Thermoplastic / White / Adhesive	6 71031 00478 9	43		940.00
760T-30WHT	Fiberglass / White / Direct to Stud	—	95.5		1,670.00

BARRIER-FREE SHOWER FLOORS

360L	Fiberglass / White	6 71031 00273 0	50		722.00
360R	Fiberglass / White	6 71031 00271 6	50		722.00

ACCESSORIES

Part No.	Description	Dimensions LxW	UPC	Lbs.	Ship Via	List Price
ENTRY RAMP						
360.100	Fiberglass / White / 12"x60"		6 71031 00275 4	25	UPS	360.00



DRAINS

SHOWER TUB™ DRAIN KIT						
60.300A	White/3060R, 3060L, 360R, 360L		6 71031 00392 8		UPS	123.00

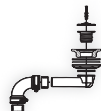

Optional Drains, Drain Seals and Strainers – See pages 18 & 19.

CONTINUOUS WATER BARRIER KIT

360.210	Continuous Water Barrier		6 71031 00479 6	0.5	UPS	89.00
---------	--------------------------	--	-----------------	-----	-----	-------

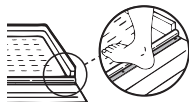

GRAB BAR

25-224220	Stainless Steel / 1.25" Inside Corner Style L / 20"x42"			6.5	UPS	165.00
-----------	---	--	--	-----	-----	--------



FOLD-DOWN SEATS

62-PH2601	Rectangular Wall Mount / 26" x 14.5"			19	UPS	480.00
62-PH2801	Rectangular Wall Mount / 28" x 14.5"			20	UPS	496.00
62-PH3201	Rectangular Wall Mount / 32" x 14.5"			22	UPS	524.00



Model 62-PH2601 shown

For a complete list of Grab Bars and Fold-Down Seats, see pages 42–47.

37" x 39" TRANSFER-SHOWER ENSEMBLES

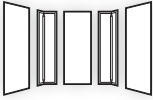
Model No.	Material / Color / Mount	UPC	Lbs.	Ship Via	List Price
DURAWALL RECTANGULAR SHOWER WALLS					
 Model 265 shown	572TWHT	Varistone™ / White / Adhesive	671031 00420 8	110	\$1,850.00
	247WHT	Thermoplastic / White / Adhesive	671031 00048 4	35	665.00
	260WHT	Thermoplastic / White / Adhesive	671031 00053 8	40	940.00
	265WHT	Thermoplastic / White / Adhesive	671031 00478 9	43	940.00

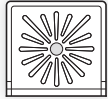

CAREGIVER® TRANSFER SHOWER FLOORS

3739M	Thermoplastic / White	671031 00353 9	35	UPS	490.00
-------	-----------------------	----------------	----	-----	--------

ACCESSORIES



Model LL-2310-PC shown

CAREGIVER® SAFETY GRAB BARS – Stainless Steel, 1.25", 18 Gauge

All stainless steel bars available in 1.25" or 1.5" diameter and in knurled or peened grip.

T STYLE

LL-2310-PC	Polished Chrome / 24"	1 1/4"	2.1	UPS	120.00
LL-2320-PC	Polished Chrome / 36"	1 1/4"	2.8	UPS	140.00



Model 01-2218KT shown

STRAIGHT

01-2218KT	Stainless Steel / 18"	1 1/4"	2	UPS	56.00
01-2224KT	Stainless Steel / 24"	1 1/4"	3	UPS	64.00
01-2236KT	Stainless Steel / 36"	1 1/4"	4	UPS	80.00



Model 07-222416KT shown

ANGLED

08-222416KT	Stainless Steel / Left Hand / 24" x 16" / 90°	1 1/4"	4	UPS	116.00
08-223216KT	Stainless Steel / Left Hand / 32" x 16" / 90°	1 1/4"	5	UPS	124.00
07-222416KT	Stainless Steel / Right Hand / 24" x 16" / 90°	1 1/4"	4	UPS	116.00
07-223216KT	Stainless Steel / Right Hand / 32" x 16" / 90°	1 1/4"	5	UPS	124.00



Model 09-223030KT shown

90°/120° ANGLED

09-223030KT	Stainless Steel / 30" x 30" / 90°	1 1/4"	7	UPS	148.00
-------------	-----------------------------------	--------	---	-----	--------



INSIDE-CORNER STYLE

25-223418	Stainless Steel / Inside Corner Style L / 34"x 18" / 90°	1 1/4"	5.5	UPS	140.00
-----------	--	--------	-----	-----	--------

CAREGIVER® FOLD-DOWN SHOWER SEATS



Model 62-PH2801 shown

62-PH2601	Rectangular Wall Mount / 26" x 14.5"	19	UPS	480.00
62-PH2801	Rectangular Wall Mount / 28" x 14.5"	20	UPS	496.00
62-PH3201	Rectangular Wall Mount / 32" x 14.5"	22	UPS	524.00

For a complete list of Grab Bars and Fold-Down Seats, see pages 42–47.

38" x 65" ADA BARRIER-FREE SHOWER ENSEMBLE

Model No.	Material / Color / Mount	UPC	Lbs.	Ship Via	List Price
	DURAWALL RECTANGULAR SHOWER WALLS				
	265WHT Thermoplastic / White / Adhesive	6 71031 00478 9	43		\$940.00

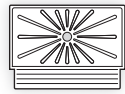

CAREGIVER® BARRIER-FREE SHOWER FLOOR

3865	Fiberglass / White	6 71031 00430 7	64		1,100.00
ENTRY RAMP — Sold separately					
360.100	Fiberglass / White / 12"x60"	6 71031 00275 4	25	UPS	360.00

ACCESSORIES

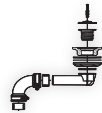

DRAINS

SHOWER TUB™ DRAIN KIT

60.300A	White/3060R, 3060L, 360R, 360L	6 71031 00392 8		UPS	123.00
---------	--------------------------------	-----------------	--	-----	--------

Optional Drains, Drain Seals and Strainers – See pages 18 & 19.

CAREGIVER® SAFETY GRAB BARS – Stainless Steel, 1.5", 18 Gauge

All stainless steel bars available in 1 1/4" or 1 1/2" diameter and in knurled or peened grip.

STRAIGHT



Model 01-5218KT shown

01-5218KT	Stainless Steel / 18"	1 1/2"	2	UPS	62.00
01-5224KT	Stainless Steel / 24"	1 1/2"	3	UPS	74.00
01-5230KT	Stainless Steel / 30"	1 1/2"	3	UPS	76.00
01-5232KT	Stainless Steel / 32"	1 1/2"	3	UPS	78.00
01-5236KT	Stainless Steel / 36"	1 1/2"	5	UPS	84.00

ANGLED



Model 07-522416KT shown

08-522416KT	Stainless Steel / Left Hand / 24" x 16" / 90°	1 1/2"	4	UPS	130.00
08-523216KT	Stainless Steel / Left Hand / 32" x 16" / 90°	1 1/2"	5	UPS	145.00
07-522416KT	Stainless Steel / Right Hand / 24" x 16" / 90°	1 1/2"	4	UPS	130.00
07-523216KT	Stainless Steel / Right Hand / 32" x 16" / 90°	1 1/2"	5	UPS	145.00

90° ANGLED



Model 09-523030KT shown

09-523030KT	Stainless Steel / 30" x 30" / 90°	1 1/2"	7	UPS	154.00
09-523636KT	Stainless Steel / 36" x 36" / 90°	1 1/2"	9	UPS	190.00

CAREGIVER® FOLD-DOWN SHOWER SEATS



Model 62-PH2601 shown

62-PH2601	Rectangular Wall Mount / 26" x 14.5"		19	UPS	480.00
62-PH2801	Rectangular Wall Mount / 28" x 14.5"		20	UPS	496.00
62-PH3201	Rectangular Wall Mount / 32" x 14.5"		22	UPS	524.00

For a complete list of Grab Bars and Fold-Down Seats, see pages 42–47.

36" NEO-ANGLE SHOWER ENSEMBLES

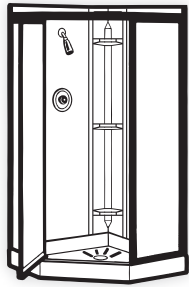

Model 736C shown

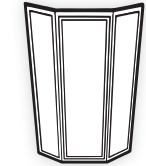

Model No.	Material / Color / Mount	UPC	Lbs.	Ship Via	List Price
DURAWALL® NEO-ANGLE SHOWER WALLS					
237WHT	Thermoplastic / White / Adhesive	6 71031 00039 2	26		\$498.00
736CWHT	Fiberglass / White / Direct to Stud	6 71031 00207 5	58		1,050.00
STYLEMATE® NEO-ANGLE SHOWER ENCLOSURES					
36.750	Bright Silver / Obscure Safety Glass	6 71031 00261 7	64		1,250.00
36.761	Bright Silver / Clear Safety Glass	6 71031 00453 6	66		1,250.00
36.762	Brushed Nickel / Clear Safety Glass	6 71031 00454 3	66		1,400.00
36.763	Black Bronze / Clear Safety Glass	6 71031 00455 0	66		1,400.00
DURABASE® NEO-ANGLE SHOWER FLOORS					
3636CM	Fiberglass / White	6 71031 00140 5	34		418.00

38" NEO-ANGLE SHOWER ENSEMBLES

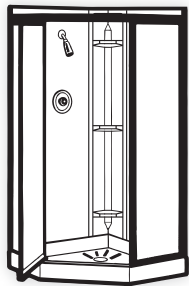

Model 738C shown

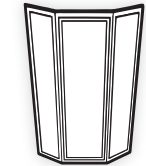

Model No.	Material / Color / Mount	UPC	Lbs.	Ship Via	List Price
DURAWALL® NEO-ANGLE SHOWER WALLS					
237WHT	Thermoplastic / White / Adhesive	6 71031 00039 2	26		498.00
738CWHT	Fiberglass / White / Direct to Stud	6 71031 00245 7	61		1,150.00
STYLEMATE® NEO-ANGLE SHOWER ENCLOSURES					
38.750	Bright Silver / Obscure Safety Glass	6 71031 00269 3	68		1,250.00
38.751	Bright Silver / Clear Safety Glass	6 71031 00456 7	68		1,350.00
38.752	Brushed Nickel / Clear Safety Glass	6 71031 00457 4	68		1,650.00
38.753	Black Bronze / Clear Safety Glass	6 71031 00458 1	68		1,650.00
DURABASE® NEO-ANGLE SHOWER FLOORS					
3838CM	Fiberglass / White	6 71031 00160 3	36		465.00

42" NEO-ANGLE SHOWER ENSEMBLES

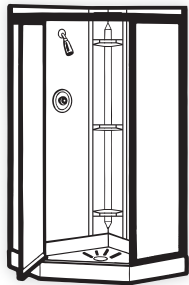

Model 742C shown

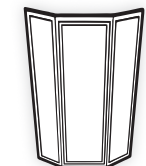

Model No.	Material / Color / Mount	UPC	Lbs.	Ship Via	List Price
DURAWALL® NEO-ANGLE SHOWER WALLS					
237WHT	Thermoplastic / White / Adhesive	6 71031 00039 2	26		498.00
742CWHT	Fiberglass / White / Direct-to-Stud	—	70		1,450.00
STYLEMATE® NEO-ANGLE SHOWER ENCLOSURES					
42.751	Bright Silver / Clear Safety Glass	6 71031 00459 8	71		1,500.00
42.752	Brushed Nickel / Clear Safety Glass	6 71031 00460 4	71		1,800.00
42.753	Black Bronze / Clear Safety Glass	6 71031 00461 1	71		1,800.00
DURABASE® NEO-ANGLE SHOWER FLOORS					
4242CM	Fiberglass / White	6 71031 00318 8	48		684.00

30" x 60" FIBERGLASS FOUR-PIECE BATHTUB ENSEMBLES – DIRECT-TO-STUD

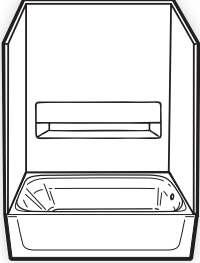
	Model No.	Material / Color / Mount	UPC	Lbs.	Ship Via	List Price
	665 TOPAZ™ 665WHT	Fiberglass / White / Direct to Stud	6 71031 00587 8	86		900.00
	670 TOPAZ™ 670WHT	Fiberglass / White / Direct to Stud	6 71031 00504 5	86		840.00
	680 TOPAZ™ 680WHT	Fiberglass / White / Direct to Stud	6 71031 00549 6	86		885.00

680WHTBB TOPAZ™

680WHTBB	Fiberglass / White / Direct to Stud	6 71031 00550 2	95.5	1,250.00
----------	-------------------------------------	-----------------	------	----------

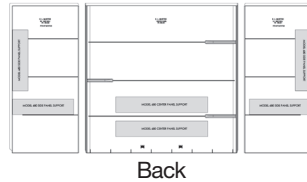
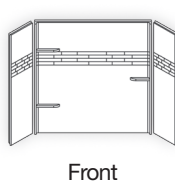

Backer Board Placement

Topaz™ 680WHTBB with backer boards preinstalled at the factory for ADA applications.

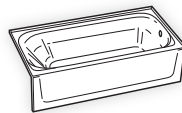

T3060 TOPAZ™ FIBERGLASS BATHTUBS

T6030L	Fiberglass / White / Left Hand	6 71031 00411 6	55	542.00
T6030R	Fiberglass / White / Right Hand	6 71031 00413 0	55	542.00
T6030L-AFD	Fiberglass / White / Left Hand	6 71031 00581 6	66	692.00
T6030R-AFD	Fiberglass / White / Right Hand	6 71031 00580 9	66	692.00

More information about Topaz™ Fiberglass Bathtubs on page 16.

32" x 60" FIBERGLASS FOUR-PIECE BATHTUB ENSEMBLES – DIRECT-TO-STUD

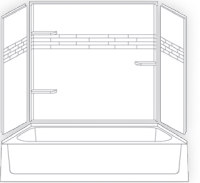
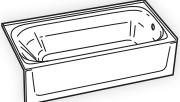
	680-32WHT TOPAZ™ 680-32WHT	Fiberglass / White / Direct to Stud	6 71031 00551 9	80	980.00
	T6032 TOPAZ™ FIBERGLASS BATHTUBS				
	T6032L	Fiberglass / White / Direct to Stud	6 71031 00542 7	52	650.00
	T6032R	Fiberglass / White / Direct to Stud	6 71031 00543 4	58	650.00

BATHTUB WALL & BATHTUB ENSEMBLES – ADHESIVE MOUNT WALLS

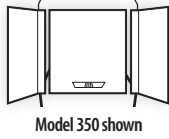
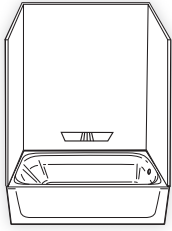

Model 350 shown

Model No.	Material / Color / Mount	UPC	Lbs.	Ship Via	List Price
FIBERGLASS & DURAWALL® BATHTUB WALLS					
572WHT	Varistone™ / White / Adhesive	6 71031 00420 8	110		\$1,850.00
350WHT	Fiberglass / White / Adhesive	6 71031 00266 2	66		1,100.00
500WHT	Fiberglass / White / Adhesive	6 71031 00181 8	63		992.00
557WHT	Fiberglass / White / Adhesive (Also fits T6032L/R)	6 71031 00336 2	46		872.00

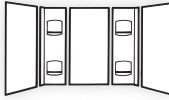
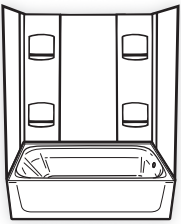

Model 952 shown

Model No.	Material / Color / Mount	UPC	Lbs.	Ship Via	List Price
THERMOPLASTIC DURAWALL® BATHTUB WALLS					
56WHT	Thermoplastic / White / Adhesive	6 71031 00288 4	28		618.00
53WHT	Thermoplastic / White / Adhesive	6 71031 00428 4	26		508.00
950	Thermoplastic / White / Adhesive	6 71031 00235 8	18		400.00

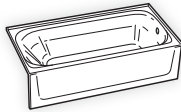

Model No.	Material / Color / Mount	UPC	Lbs.	Ship Via	List Price
TOPAZ™ BATHTUBS					
T6030L	Fiberglass / White / Left Hand	6 71031 00411 6	55		542.00
T6030R	Fiberglass / White / Right Hand	6 71031 00413 0	55		542.00
T6030L-AFD	Fiberglass / White / Left Hand	6 71031 00581 6	66		692.00
T6030R-AFD	Fiberglass / White / Right Hand	6 71031 00580 9	66		692.00

ACCESSORIES

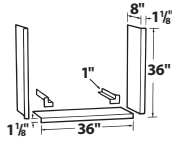

DURATRIM™ FIBERGLASS WINDOW TRIM KIT

– Fit windows up to 36" wide by 8" sill depth.

Part No.	Description	Material	UPC	Lbs.	Ship Via	List Price
300.600W	White	Fiberglass	6 71031 00060 6	9	UPS	\$300.00

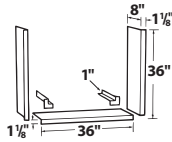

DURATRIM™ THERMOPLASTIC WINDOW TRIM KIT

– Fit windows up to 36" wide by 8" sill depth.

Part No.	Description	Material	UPC	Lbs.	Ship Via	List Price
52.600W	Thermoplastic / White / Adhesive		6 71031 00185 6	3.1	UPS	165.00

Model No.	Style / Mount	Lbs.	Cu. Ft.	Ctn. Qty.	List Price
-----------	---------------	------	---------	-----------	------------

FIBREGLASS SINK & WHITE CABINET

HUNTSVILLE SERIES

Includes, the Mustee #10 Drop-in sink with custom White doors, pre-drilled for knob hardware. **18" of shelf storage beneath tub.**

10-SSW	Single / Floor	75	13.7	1	700.00
---------------	----------------	----	------	---	---------------

Huntsville Laundry Combos offer the following cabinet accessories and finishing touches.

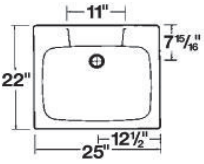
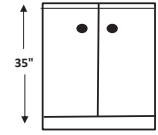
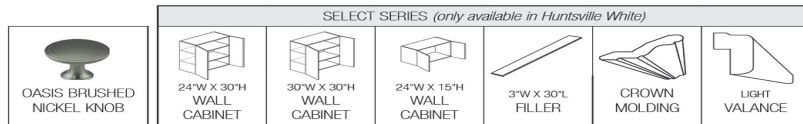

Combo dimensions: 25"W x 22"D x 35"H

FIBREGLASS SINK & CUSTOM CABINET

IMPRESSION SERIES

Includes, the Mustee #25 Vector Drop-in sink with CUSTOM soft close doors, pre-drilled for knob hardware. **16 different door styles available. Visit DDMPro.ca for more details.**

25-IMP	Single / Floor	75	13.7	1	800.00
25.300	UTILITY RACK - White	3	.5	1	100.00

Impression Laundry Combos offer the following cabinet accessories and finishing touches.

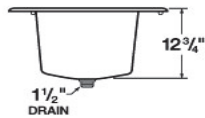
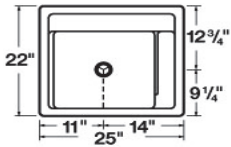
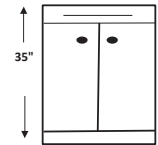
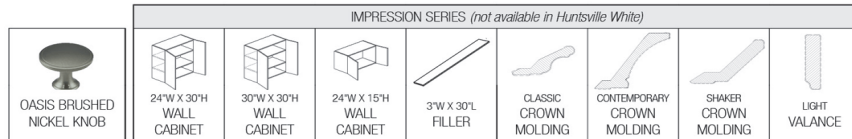

Combo dimensions: 25"W x 22"D x 35"H

Please visit www.ddmpro.ca/ for more details on our "quick ship" vanity program. Pricing and delivery available upon request.

IMPRESSION and HUNTSVILLE Bath Furniture Vanity Combos with Quartz and Marble Tops

(Jasper Impression Series shown below)



<p>30"</p>  <p>VFHS3021-ISJ-TK</p>	<p>30"</p>  <p>MIRROR-2430-ISJ</p>	<p>15"</p> <p>75" Height 18" Depth</p>  <p>VL1DS1575L-ISJ-TK</p>	<p>15"</p>  <p>VL1DS1575R-ISJ-TK</p>	<p>36"</p>  <p>VFHS3621-ISJ-TK</p>	<p>SSS-TALL-JS (to go between Linen tower & wall)</p> <p>SSS-BASE-JS (To go between vanity & wall or Vanity & Linen Tower)</p> <p>36"</p>  <p>V2DS3621R-ISJ-TK</p>						
<p>30"</p>  <p>V2DS3021L-ISJ-TK</p>	<p>30"</p>  <p>V2DS3021R-ISJ-TK</p>	<p>48"</p>  <p>V4DS4821-ISJ-TK</p>	<p>60"</p>  <p>V4DS6021-ISJ-TK</p>	<p>60" with double bowl top</p>  <p>V2DS6021-ISJ-TK</p>	<p>Your choice of Prism Quartz single hole top:</p> <table border="0"> <tr> <td></td> <td></td> <td></td> </tr> <tr> <td>Porcelain White (Q3007) <small>*Faucets not included.</small></td> <td>Ocean Grey (Q1002) <small>*Faucets not included.</small></td> <td>Carrara White (Q1007) <small>*Faucets not included.</small></td> </tr> </table>				Porcelain White (Q3007) <small>*Faucets not included.</small>	Ocean Grey (Q1002) <small>*Faucets not included.</small>	Carrara White (Q1007) <small>*Faucets not included.</small>
											
Porcelain White (Q3007) <small>*Faucets not included.</small>	Ocean Grey (Q1002) <small>*Faucets not included.</small>	Carrara White (Q1007) <small>*Faucets not included.</small>									



STRAIGHT - CHROME, 1" DIA.



Model No.	Colour	Diameter	Length	Description	List Price
01-1112KL	Chrome	1"	12"	Knurled Grip, Adjustable flange	\$36.00
01-1116KL	Chrome	1"	16"	Knurled Grip, Adjustable flange	38.00
01-1118KL	Chrome	1"	18"	Knurled Grip, Adjustable flange	40.00
01-1124KL	Chrome	1"	24"	Knurled Grip, Adjustable flange	45.00
01-1130KL	Chrome	1"	30"	Knurled Grip, Adjustable flange	50.00
01-1132KL	Chrome	1"	32"	Knurled Grip, Adjustable flange	52.00
01-1136KL	Chrome	1"	36"	Knurled Grip, Adjustable flange	56.00
01-1142KL	Chrome	1"	42"	Knurled Grip, Adjustable flange	60.00
01-1148KL	Chrome	1"	48"	Knurled Grip, Adjustable flange	65.00

STRAIGHT - CHROME, 1.25" DIA.

Model No.	Colour	Diameter	Length	Description	List Price
<i>Knurled Grip</i>					
01-2912KT-PC	Chrome	1.25"	12"	Knurled Grip, Hidden Flange	72.00
01-2918KT-PC	Chrome	1.25"	18"	Knurled Grip, Hidden Flange	80.00
01-2924KT-PC	Chrome	1.25"	24"	Knurled Grip, Hidden Flange	85.00

STRAIGHT - MATT BLACK, 1.25" DIA.



Model No.	Colour	Diameter	Length	Description	List Price
<i>Knurled Grip</i>					
01-2712KT-MB	Matt Black	1.25"	12"	Knurled Grip, Hidden Flange	84.00
01-2716KT-MB	Matt Black	1.25"	16"	Knurled Grip, Hidden Flange	100.00
01-2718KT-MB	Matt Black	1.25"	18"	Knurled Grip, Hidden Flange	110.00
01-2724KT-MB	Matt Black	1.25"	24"	Knurled Grip, Hidden Flange	130.00
01-2732KT-MB	Matt Black	1.25"	32"	Knurled Grip, Hidden Flange	136.00
<i>Smooth Grip</i>					
01-2712ST-MB	Matt Black	1.25"	12"	Knurled Grip, Hidden Flange	80.00
01-2716ST-MB	Matt Black	1.25"	16"	Knurled Grip, Hidden Flange	95.00
01-2718ST-MB	Matt Black	1.25"	18"	Knurled Grip, Hidden Flange	100.00
01-2724ST-MB	Matt Black	1.25"	24"	Knurled Grip, Hidden Flange	115.00
01-2732ST-MB	Matt Black	1.25"	32"	Knurled Grip, Hidden Flange	130.00

STRAIGHT - STAINLESS STEEL, 1.25" DIA.



Model No.	Colour	Diameter	Length	Description	List Price
<i>Knurled Grip</i>					
01-2212KT	Stainless	1.25"	12"	Knurled Grip, Hidden Flange	45.00
01-2216KT	Stainless	1.25"	16"	Knurled Grip, Hidden Flange	52.00
01-2218KT	Stainless	1.25"	18"	Knurled Grip, Hidden Flange	56.00
01-2224KT	Stainless	1.25"	24"	Knurled Grip, Hidden Flange	64.00
01-2230KT	Stainless	1.25"	30"	Knurled Grip, Hidden Flange	70.00
01-2232KT	Stainless	1.25"	32"	Knurled Grip, Hidden Flange	74.00
01-2236KT	Stainless	1.25"	36"	Knurled Grip, Hidden Flange	80.00
01-2242KT	Stainless	1.25"	42"	Knurled Grip, Hidden Flange	85.00
01-2248KT	Stainless	1.25"	48"	Knurled Grip, Hidden Flange	90.00
<i>Peened Grip</i>					
01-2212PT	Stainless	1.25"	12"	Peened Grip, Hidden Flange	45.00
01-2216PT	Stainless	1.25"	16"	Peened Grip, Hidden Flange	52.00
01-2218PT	Stainless	1.25"	18"	Peened Grip, Hidden Flange	56.00
01-2224PT	Stainless	1.25"	24"	Peened Grip, Hidden Flange	64.00
01-2230PT	Stainless	1.25"	30"	Peened Grip, Hidden Flange	70.00
01-2232PT	Stainless	1.25"	32"	Peened Grip, Hidden Flange	74.00
01-2236PT	Stainless	1.25"	36"	Peened Grip, Hidden Flange	80.00
01-2242PT	Stainless	1.25"	42"	Peened Grip, Hidden Flange	85.00
01-2248PT	Stainless	1.25"	48"	Peened Grip, Hidden Flange	90.00
<i>Shur-Grip</i>					
01-2212GT	Stainless	1.25"	12"	Shurgrip, Hidden Flange	58.00
01-2216GT	Stainless	1.25"	16"	Shurgrip, Hidden Flange	62.00
01-2218GT	Stainless	1.25"	18"	Shurgrip, Hidden Flange	70.00
01-2224GT	Stainless	1.25"	24"	Shurgrip, Hidden Flange	78.00

STRAIGHT - SHURGRIP WHITE, 1.25" DIA.



Model No.	Colour	Diameter	Length	Description	List Price
01-2612GT01	White	1.25"	12"	White Shurgrip, Hidden Flange	72.00
01-2616GT01	White	1.25"	16"	White Shurgrip, Hidden Flange	76.00
01-2618GT01	White	1.25"	18"	White Shurgrip, Hidden Flange	82.00
01-2624GT01	White	1.25"	24"	White Shurgrip, Hidden Flange	90.00
01-2630GT01	White	1.25"	30"	White Shurgrip, Hidden Flange	110.00
01-2632GT01	White	1.25"	32"	White Shurgrip, Hidden Flange	120.00
01-2636GT01	White	1.25"	36"	White Shurgrip, Hidden Flange	132.00

STRAIGHT GRAB BARS - CODE APPROVED, 1.5" DIA.



Model No.	Colour	Diameter	Length	Description	List Price
<i>Knurled</i>					
01-5212KT	Stainless	1.5"	12"	Knurled Grip, Hidden Flange	\$52.00
01-5216KT	Stainless	1.5"	16"	Knurled Grip, Hidden Flange	58.00
01-5218KT	Stainless	1.5"	18"	Knurled Grip, Hidden Flange	62.00
01-5224KT	Stainless	1.5"	24"	Knurled Grip, Hidden Flange	74.00
01-5230KT	Stainless	1.5"	30"	Knurled Grip, Hidden Flange	76.00
01-5232KT	Stainless	1.5"	32"	Knurled Grip, Hidden Flange	80.00
01-5236KT	Stainless	1.5"	36"	Knurled Grip, Hidden Flange	84.00
01-5242KT	Stainless	1.5"	42"	Knurled Grip, Hidden Flange	92.00
<i>Peened</i>					
01-5212PT	Stainless	1.5"	12"	Peened Grip, Hidden Flange	52.00
01-5216PT	Stainless	1.5"	16"	Peened Grip, Hidden Flange	58.00
01-5218PT	Stainless	1.5"	18"	Peened Grip, Hidden Flange	62.00
01-5224PT	Stainless	1.5"	24"	Peened Grip, Hidden Flange	74.00
01-5230PT	Stainless	1.5"	30"	Peened Grip, Hidden Flange	76.00
01-5232PT	Stainless	1.5"	32"	Peened Grip, Hidden Flange	80.00
01-5236PT	Stainless	1.5"	36"	Peened Grip, Hidden Flange	84.00
01-5242PT	Stainless	1.5"	42"	Peened Grip, Hidden Flange	92.00

90 DEGREE, 30" x 30" BAR - CODE APPROVED, 1.5" DIA.



Model No.	Colour	Diameter	Length	Description	List Price
<i>Knurled</i>					
09-523030KT	Stainless	1.5"	30" x 30"	Knurled Grip, Hidden Flange	158.00
09-5233636KT	Stainless	1.5"	36" x 36"	Knurled Grip, Hidden Flange	192.00
<i>Peened</i>					
09-523030PT	Stainless	1.5"	30" x 30"	Peened Grip, Hidden Flange	158.00
09-523636PT	Stainless	1.5"	36" x 36"	Peened Grip, Hidden Flange	192.00

90 DEGREE ANGLE BAR - CODE APPROVED, 1.5" DIA.

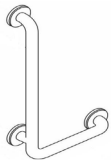

Right-hand mounted

Model No.	Colour	Diameter	Length	Description	List Price
<i>Right-Hand</i>					
07-522416KT	Stainless	1.5"	24" x 16"	Knurled Grip, Hidden Flange	130.00
07-522416PT	Stainless	1.5"	24" x 16"	Peened Grip, Hidden Flange	130.00
07-523216KT	Stainless	1.5"	32" x 16"	Knurled Grip, Hidden Flange	145.00
07-523216PT	Stainless	1.5"	32" x 16"	Peened Grip, Hidden Flange	145.00
<i>Left-Hand</i>					
08-522416KT	Stainless	1.5"	24" x 16"	Knurled Grip, Hidden Flange	\$130.00
08-522416PT	Stainless	1.5"	24" x 16"	Peened Grip, Hidden Flange	130.00
08-523216KT	Stainless	1.5"	32" x 16"	Knurled Grip, Hidden Flange	145.00
08-523216PT	Stainless	1.5"	32" x 16"	Peened Grip, Hidden Flange	145.00

90 DEGREE ANGLE BAR, CHROME, 1" DIA.



Model No.	Colour	Diameter	Length	Description	List Price
<i>Right Hand</i>					
07-112416KL	Chrome	1"	16"x 24"	Knurled, Adjustable Flange	\$85.00
07-113216KL	Chrome	1"	16"x 32"	Knurled, Adjustable Flange	92.00
<i>Left Hand</i>					
08-112416KL	Chrome	1"	16"x 24"	Knurled, Adjustable Flange	85.00
08-113216KL	Chrome	1"	16"x 32"	Knurled, Adjustable Flange	92.00

90 DEGREE ANGLE BAR, STAINLESS, 1.25" DIA.

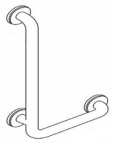

Right-hand mounted

Model No.	Colour	Diameter	Length	Description	List Price
<i>Right Hand</i>					
07-222416KT	Stainless	1.25"	16"x 24"	Knurled Grip, Hidden Flange	116.00
07-222416PT	Stainless	1.25"	16"x 24"	Peened Grip, Hidden Flange	116.00
07-223216KT	Stainless	1.25"	16"x 32"	Knurled Grip, Hidden Flange	124.00
07-223216PT	Stainless	1.25"	16"x 32"	Peened Grip, Hidden Flange	124.00
07-224030PT	Stainless	1.25"	40"x 30"	Peened Grip, Hidden Flange	152.00
<i>Left Hand</i>					
08-222416KT	Stainless	1.25"	16"x 24"	Knurled Grip, Hidden Flange	116.00
08-222416PT	Stainless	1.25"	16"x 24"	Peened Grip, Hidden Flange	116.00
08-223216KT	Stainless	1.25"	16"x 32"	Knurled Grip, Hidden Flange	124.00
08-223216PT	Stainless	1.25"	16"x 32"	Peened Grip, Hidden Flange	124.00
08-224030PT	Stainless	1.25"	40"x 30"	Peened Grip, Hidden Flange	152.00

90 DEGREE ANGLE BAR, WHITE, 1.25" DIA.



Model No.	Colour	Diameter	Length	Description	List Price
<i>Right Hand</i>					
07-262416GT01	White	1.25"	16"x 24"	White Shurgrip, Hidden Flange	165.00
07-263216GT01	White	1.25"	16"x 32"	White Shurgrip, Hidden Flange	182.00
<i>Left Hand</i>					
08-262416GT01	White	1.25"	16"x 24"	White Shurgrip, Hidden Flange	165.00
08-263216GT01	White	1.25"	16"x 32"	White Shurgrip, Hidden Flange	182.00

90 DEGREE 30"x 30", 1.25" DIA.



Model No.	Colour	Diameter	Length	Description	List Price
<i>Knurled Grip</i>					
09-223030KT	Stainless	1.25"	30"x 30"	Knurled Grip, Hidden Flange	148.00
09-223636KT	Stainless	1.25"	36"x 36"	Knurled Grip, Hidden Flange	184.00
<i>Peened Grip</i>					
09-223030PT	Stainless	1.25"	30"x 30"	Peened Grip, Hidden Flange	148.00
09-223636PT	Stainless	1.25"	36"x 36"	Peened Grip, Hidden Flange	184.00
<i>Matt Black w/ Knurled & Smooth Grip</i>					
09-273030KT-MB	Matt Black	1.25"	30"x 30"	Knurled Grip, Hidden Flange	285.00
09-273030ST-MB	Matt Black	1.25"	30"x 30"	Smooth Grip, Hidden Flange	275.00

INSIDE CORNER RAIL, 1.25" DIA.

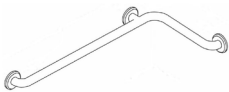

Model No.	Colour	Diameter	Length	Description	List Price
<i>Knurled Grip</i>					
25-223418KT	Stainless	1.25"	34"x 18"	Knurled Grip, Hidden Flange	140.00
25-224220KT	Stainless	1.25"	42"x 20"	Knurled Grip, Hidden Flange	165.00
<i>Peened Grip</i>					
25-223418PT	Stainless	1.25"	34"x 18"	Peened Grip, Hidden Flange	140.00
25-224220PT	Stainless	1.25"	42"x 20"	Peened Grip, Hidden Flange	165.00
<i>Shurgrip-White</i>					
25-263418GT01	White	1.25"	34"x 18"	White Shurgrip, Hidden Flange	185.00
25-264220GT01	White	1.25"	42"x 20"	White Shurgrip, Hidden Flange	250.00

FLIP-UP SAFETY BARS

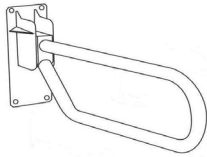

Model No.	Colour	Diameter	Length	Description	List Price
96-2230K/W01	Stainless	1.25"	30"	Knurled Grip, White Mount, Locking	\$232.00
96-2230P/W01	Stainless	1.25"	30"	Peened Grip, White Mount, Locking	232.00
97-2230K	Stainless	1.25"	30"	Knurled Grip, Stnl.S, Motion Friction	280.00
97-2230P	Stainless	1.25"	30"	Peened Grip, Stnl.S, Motion Friction	280.00
97-5230K	Stainless	1.5"	30"	Knurled Grip, Stnl.S, Motion Friction	310.00
97-5230P	Stainless	1.5"	30"	Peened Grip, Stnl.S, Motion Friction	310.00
98-2230K	Stainless	1.25"	30"	Knurled Grip, Stnl.S, Heavy duty support	780.00
98-2230P	Stainless	1.25"	30"	Peened Grip, Stnl.S, Heavu duty support	780.00
96-CESS	Stainless	33"	Floor to bar	In-wall Support Column (96-Bar)	185.00
97-CESS	Stainless	33"	Floor to bar	In wall Support Column (97-Bar)	190.00
96-CE33SS	Stainless	33"	Floor to bar	Floor Mnt. Support Column (96-Bar)	518.00
97-CE33SS	Stainless	33"	Floor to bar	Floor Mnt. Support Column (97-Bar)	532.00
96T	Stainless			Toilet paper holder (1.25" dia.)	36.00
99-52T	Stainless			Toilet paper holder (1.5" dia.)	36.00

FOLD-DOWN PADDED & PHENOLIC SHOWER SEATS

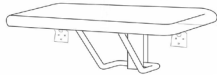

Model No.	Colour	Diameter	Length	Description	List Price
RECTANGULAR SEAT, WALL MOUNT					
62-PA2601	White	26"	16"	White Padded Seat, 400lb load cap.	480.00
62-PH2601	White	26"	16"	White Phenolic Seat, 400lb load cap.	480.00
62-PH2615	Woodgrain	26"	16"	Woodgrain Seat, 400lb load cap.	480.00
62-PA2801	White	28"	16"	White Padded Seat, 400lb load cap.	496.00
62-PH2801	White	28"	16"	White Phenolic Seat, 400lb load cap.	496.00
62-PH2815	Woodgrain	28"	16"	Woodgrain Seat, 400lb load cap.	496.00
62-PA3201	White	32"	16"	White Padded Seat, 400lb load cap.	524.00
62-PH3201	White	32"	16"	White Phenolic Seat, 400lb load cap.	524.00
62-PH3215	Woodgrain	32"	16"	Woodgrain Seat, 400lb load cap.	524.00
RECTANGULAR JR. SEAT, WALL MOUNT					
63-PA1451601	White	16"	14 1/2"	White Phenolic Seat, 250lb load cap.	382.00
63-PH1451601	White	16"	14 1/2"	White Phenolic Seat, 250lb load cap.	382.00
63-PH1451615	Woodgrain	16"	14 1/2"	Woodgrain Seat, 250lb load cap.	382.00
63-PA1451801	White	18"	14 1/2"	White Phenolic Seat, 250lb load cap.	412.00
63-PH1451801	White	18"	14 1/2"	White Phenolic Seat, 250lb load cap.	412.00
63-PH1451815	Woodgrain	18"	14 1/2"	Woodgrain Seat, 250lb load cap.	412.00

FOR LEFT OR RIGHT-SIDE CONFIGURATIONS OR FLIP-UP SEATS WITH LEGS, PLEASE CONTACT DDMPRO.

PREMIUM SHOWER SEATS - LIFE LINE

LIFELINE SEATS AVAILABLE WITH POLOSHED CHROME OR MATT BLACK FRAMES.

Model No.	Colour	Size	Description	List Price
LL-WAL18-PC	Walnut	18" x 14 1/2"	Solid wood w/Chrome Frame, 500lb	500.00
LL-WAL26-PC	Walnut	26" x 14 1/2"	Solid wood w/Chrome Frame, 500lb	532.00
LL-WAL18-MB	Walnut	18" x 14 1/2"	Solid wood w/Matt Black Frame, 500lb	460.00
LL-WAL26-MB	Walnut	26" x 14 1/2"	Solid wood w/Matt Black Frame, 500lb	528.00
LL-TEA18-PC	Teakwood	18" x 14 1/2"	Solid wood w/Chrome Frame, 500lb	662.00
LL-TEA26-PC	Teakwood	26" x 14 1/2"	Solid wood w/Chrome Frame, 500lb	732.00
LL-TEA18-MB	Teakwood	18" x 14 1/2"	Solid wood w/Matt Black Frame, 500lb	620.00
LL-TEA26-MB	Teakwood	26" x 14 1/2"	Solid wood w/Matt Black Frame, 500lb	724.00



Tub/Shower Valve Ring Grab Bar

The Tub/Shower Valve (3/4 circle grab bar) mounts around the shower valve and allows you to enter and exit the tub/shower with ease, lending a stable hand while showering.



Model No.
LL-2010-PC - \$ 140.00
LL-2010-BN - \$ 140.00
LL-2010-MB - \$ 150.00

Toilet Paper Holder Semisphere Grab Bar

This half circle grab bar/toilet paper combo mounts conveniently beside your toilet and offers a stable hand as well as the convenience of having toilet paper incorporated into the center arm.



Model No.
LL-2020-PC - \$ 150.00
LL-2020-MB - \$ 150.00

Towel Bar Grab Bar

A grab bar and a towel bar combined into one unique piece. This combo unit can be mounted on your bathroom wall or in your shower and offers that stable secure hand when reaching for towels or washcloths.



Model No.
24" LL-2040-PC - \$ 120.00
24" LL-2040-BN - \$ 120.00
24" LL-2040-MB - \$ 125.00

Skyline Grab Bar

Fashioned with clean modern lines, the Skyline Grab Bar can be mounted horizontally or vertically. This unique grab bar has a very smart design which is both sound and secure as well as stylish. Its one of a kind look has both a pleasing feel and appearance.

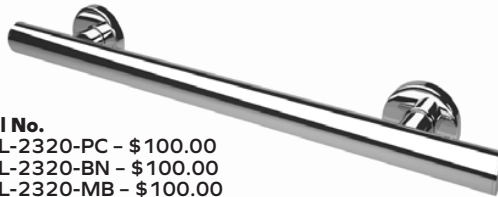

Model No.
18" LL-2320-PC - \$ 100.00
18" LL-2320-BN - \$ 100.00
18" LL-2320-MB - \$ 100.00
24" LL-2310-PC - \$ 120.00
24" LL-2310-BN - \$ 120.00
24" LL-2310-MB - \$ 120.00

Wave Grab Bar

The Wave Grab Bar (mounted horizontally or vertically) is very unique and debonair. Its smart design is both sound and secure as well as stylish. Fashioned with a subtle wave like bend, its one of a kind modern look is both pleasing to the hand and eye.



Model No.
18" LL-2070-PC - \$ 110.00
24" LL-2080-PC - \$ 110.00
18" LL-2070-BN - \$ 110.00
24" LL-2080-BN - \$ 110.00
18" LL-2070-MB - \$ 110.00
24" LL-2080-MB - \$ 120.00

Sweeping Grab Bar

The gentle curve of this stylish grab bar provides an esthetically pleasing look as well as a completely functional grab bar. We have specifically located the two mounting points at 16" on center. This allows additional ease in mounting on wall studs.



Model No.
24" LL-2100-PC - \$ 110.00
24" LL-2100-BN - \$ 110.00
24" LL-2100-MB - \$ 110.00

Please indicate (LH) for lefthand or (RH) for righthand when ordering.*

Designer Toilet Paper Holder Grab Bar

The dual functioning design of this Designer Grab Bar combines strength with the convenience of a toilet paper holder. The simplicity of its style and features will compliment any bathroom decor.



Model No.
LL-2030-PC - \$ 140.00
LL-2030-MB - \$ 130.00

Shampoo Shelf Grab Bar

This unique grab bar incorporates support for safe being and also functions as a shelf for shampoo and other toiletries. Furthermore the innovative shelf features a removable tray that resists mold and mildew for easy cleaning.



Model No.
LL-2050-PC - \$ 130.00
LL-2050-BN - \$ 130.00
LL-2050-MB - \$ 130.00

Soap Basket Grab Bar

Beautiful and stylish, the intelligent design of this grab bar/soap basket combo keeps you well organized and safe with soap near by and readily available.



*(RH) Right-hand shown

Model No.
LL-2060-PC - \$ 120.00
LL-2060-BN - \$ 110.00

Please indicate (LH) for lefthand or (RH) for righthand when ordering.*

Soap Basket Grab Bar

This unique shelf blended with an 1-1/4" curved grab bar incorporates a shelf for shampoo and other toiletries. The removable tray's surface is mold and mildew resistant. But to complete a custom look, cut and secure a piece of matching tile.



Model No.
LL-2200-PC - \$ 110.00
LL-2200-BN - \$ 110.00
LL-2200-MB - \$ 110.00

Available finishes

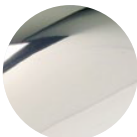

Polished chrome



Brushed Nickel



Matt Black

Please indicate (PC) for Polished Chrome, (MB) for Matt Black or (BN) for Brushed Nickel when ordering.

The Life Line Collection is a unique selection of products that will make your bathroom a much safer environment. Combined with simple installation, this makes our Life Line Collection the #1 choice for designers & remodelers.

- The Life Line Collection features corrosion resistant 1.25" dia. x 18 gauge heavy duty stainless steel.
- Mounting hardware included for both hollow walls and stud or blocked walls.
- Meets and exceeds ADA & ANSI standards (500 lbs)
- Not including Soap Basket with Grab Bar (250 lbs)



Direct Distributors has been serving the Plumbing and Building Sector since 1996. We always strive to bring our customers high-quality products that bring value to their business. From our Pickering, Ontario warehouse, we ship products to Wholesalers and Retailers across all cities in Canada, including Quebec and beyond.

Code Compliance as indicated, most Mustee products are listed by:

International Association of Plumbing and Mechanical Officials (IAPMO®) — United States 

Warnock Hersey® — Canada 
Intertek



RESIDENTIAL
COMMERCIAL
HEALTHCARE
INSTITUTIONAL

A horizontal band with a blue background and numerous water droplets of varying sizes, creating a textured, reflective effect.

DIRECT DISTRIBUTORS & MARKETING PROFESSIONALS



Direct Distributors and Marketing Professionals
817 Brock Road Unit # 9,
Pickering, Ontario L1W 3L9

Phone: 905-420-0716 Fax: 905-420-3582

Email: info@ddmpro.ca

WWW.DDMPRO.CA